

adaptec[®]

Serial ATA II
1430SA, 1420SA, 1220SA
HostRAID Controllers
Installation and User's Guide

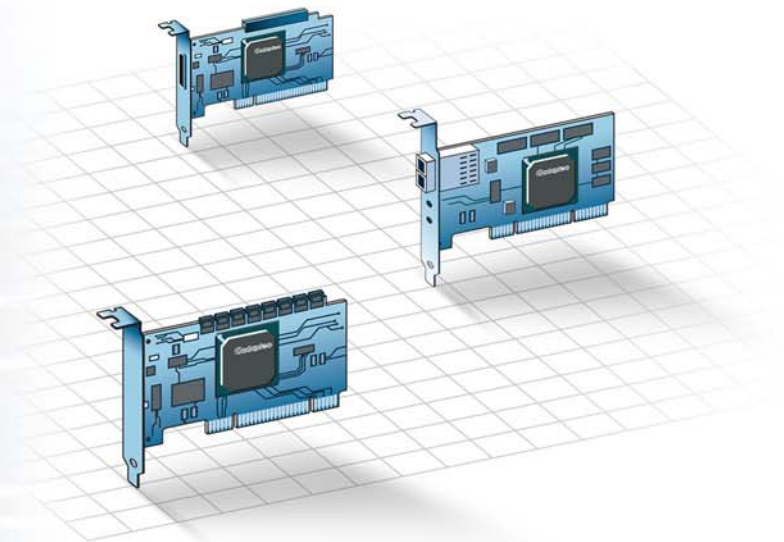

Copyright

©2006 Adaptec, Inc. All rights reserved. No part of this publication may be reproduced, stored in a retrieval system, or transmitted in any form or by any means, electronic, mechanical, photocopying, recording or otherwise, without the prior written consent of Adaptec, Inc., 691 South Milpitas Blvd., Milpitas, CA 95035.

Trademarks

Adaptec, Adaptec Storage Manager, *SCSISelect*, *SATASelect*, *SerialSelect* and the Adaptec logo are trademarks of Adaptec, Inc., which may be registered in some jurisdictions.

Microsoft and Windows are trademarks of Microsoft Corporation in the US and other countries, used under license.

Red Hat is a trademark of Red Hat, Inc. in the US and other countries, used under license.

Novell and NetWare are trademarks of Novell, Inc. in the US and other countries, used under license.

All other trademarks are the property of their respective owners.

Changes

The material in this document is for information only and is subject to change without notice. While reasonable efforts have been made in the preparation of this document to assure its accuracy, Adaptec, Inc. assumes no liability resulting from errors or omissions in this document, or from the use of the information contained herein.

Adaptec reserves the right to make changes in the product design without reservation and without notification to its users.

Disclaimer

IF THIS PRODUCT DIRECTS YOU TO COPY MATERIALS, YOU MUST HAVE PERMISSION FROM THE COPYRIGHT OWNER OF THE MATERIALS TO AVOID VIOLATING THE LAW WHICH COULD RESULT IN DAMAGES OR OTHER REMEDIES.

Adaptec Customer Support

If you have questions about installing or using your Adaptec product, check this document first—you will find answers to most of your questions. If you need further assistance, use the support options listed below. To expedite your service, have your computer in front of you.

Technical Support Identification (TSID) Number

- Before contacting Technical Support, you need your unique 12-digit TSID number. The TSID number identifies your product and support status.
- The TSID number is included on a white, bar-coded label, like this example:

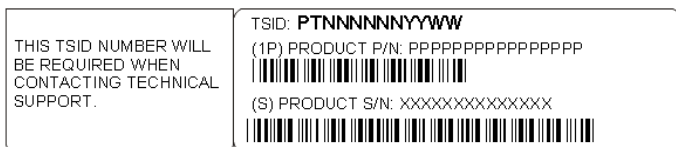

- Affix a copy of the TSID label to the CD jacket so that you don't lose it.

North America

- Visit our Web site at www.adaptec.com.
- Search the Adaptec Support Knowledgebase (ASK) at ask.adaptec.com for articles, troubleshooting tips, and frequently asked questions for your product.
- For information about Adaptec's support options, call +1 408-957-2550, 24 hours per day, 7 days per week. To speak with a Technical Support Specialist,
 - For **Hardware** products call +1 408-934-7274, Monday to Friday, 5:00 A.M. to 5:00 P.M., Pacific Time.
 - For **RAID and Fibre Channel** products call +1 321-207-2000, Monday to Friday, 5:00 A.M. to 5:00 P.M., Pacific Time.
- For support via e-mail, submit your question at ask.adaptec.com.
- You can order Adaptec products, including accessories and cables, by calling +1 408-957-7274. Or, you can order cables online at www.adaptec.com/buy-cables.

Europe

- Visit our Web site at www.adaptec-europe.com.
- **German:** Call +49 89 43 66 55 22, Monday to Friday, 9:00 to 17:00, CET. For support via e-mail, submit your question at ask-de.adaptec.com.
- **French:** Call +49 89 43 66 55 33, Monday to Friday, 9:00 to 17:00, CET. For support via e-mail, submit your question at ask-fr.adaptec.com.
- **English:** Call +49 89 43 66 55 44, Monday to Friday, 9:00 to 17:00, GMT. For support via e-mail, submit your question at ask.adaptec.com.
- You can order Adaptec cables online at www.adaptec.com/buy-cables.

Japan

- Visit our Web site at www.adaptec.co.jp.
- Call +81-3-3831-5190.

Limited 3-Year Hardware Warranty

1. Adaptec, Inc. ("Adaptec") warrants to the purchaser of this product that it will be free from defects in material and workmanship for a period of three (3) years from the date of purchase. If the product should become defective within the warranty period, Adaptec, at its option, will repair or replace the product, or refund the purchaser's purchase price for the product, provided it is delivered at the purchaser's expense to an authorized Adaptec service facility or to Adaptec.
2. Repair or replacement parts or products will be furnished on an exchange basis and will either be new or reconditioned. All replaced parts or products shall become the property of Adaptec. This warranty shall not apply if the product has been damaged by accident, misuse, abuse or as a result of unauthorized service or parts.
3. Warranty service is available to the purchaser by delivering the product during the warranty period to an authorized Adaptec service facility or to Adaptec and providing proof of purchase price and date. The purchaser shall bear all shipping, packing and insurance costs and all other costs, excluding labor and parts, necessary to effectuate repair, replacement or refund under this warranty.
4. For more information on how to obtain warranty service, write or telephone Adaptec at 691 South Milpitas Boulevard, Milpitas, CA 95035, (800) 959-7274.
5. THIS LIMITED WARRANTY DOES NOT EXTEND TO ANY PRODUCT WHICH HAS BEEN DAMAGED AS A RESULT OF ACCIDENT, MISUSE, ABUSE, OR AS A RESULT OF UNAUTHORIZED SERVICE OR PARTS.
6. THIS WARRANTY IS IN LIEU OF ALL OTHER EXPRESS WARRANTIES WHICH NOW OR HEREAFTER MIGHT OTHERWISE ARISE RESPECT TO THIS PRODUCT. IMPLIED WARRANTIES, INCLUDING THOSE OF MERCHANTABILITY, FITNESS FOR A PARTICULAR PURPOSE AND NON-INFRINGEMENT SHALL (A) HAVE NO GREATER DURATION THAN 3 YEARS FROM THE DATE OF PURCHASE, (B) TERMINATE AUTOMATICALLY AT THE EXPIRATION OF SUCH PERIOD AND (C) TO THE EXTENT PERMITTED BY LAW BE EXCLUDED. IN THE EVENT THIS PRODUCT BECOMES DEFECTIVE DURING THE WARRANTY PERIOD, THE PURCHASER'S EXCLUSIVE REMEDY SHALL BE REPAIR, REPLACEMENT OR REFUND AS PROVIDED ABOVE. INCIDENTAL OR CONSEQUENTIAL DAMAGES, INCLUDING WITHOUT LIMITATION LOSS OF DATA, ARISING FROM BREACH OF ANY EXPRESS OR IMPLIED WARRANTY ARE NOT THE RESPONSIBILITY OF ADAPTEC AND, TO THE EXTENT PERMITTED BY LAW, ARE HEREBY EXCLUDED BOTH FOR PROPERTY DAMAGE, AND TO THE EXTENT NOT UNCONSCIONABLE, FOR PERSONAL INJURY DAMAGE.
7. SOME STATES DO NOT ALLOW THE EXCLUSION OR LIMITATION OF INCIDENTAL OR CONSEQUENTIAL DAMAGES FOR CONSUMER PRODUCTS, AND SOME STATES DO NOT ALLOW LIMITATIONS ON HOW LONG AN IMPLIED WARRANTY LASTS, SO THE ABOVE LIMITATION OR EXCLUSIONS MAY NOT APPLY TO YOU.
8. This warranty gives you specific legal rights, and you may also have other rights which vary from state to state.

Regulatory Compliance Statements

Federal Communications Commission Radio Frequency Interference Statement

WARNING: Changes or modifications to this unit not expressly approved by the party responsible for compliance could void the user's authority to operate the equipment.

This equipment has been tested and found to comply with the limits for a Class B digital device, pursuant to Part 15 of the FCC rules. These limits are designed to provide reasonable protection against harmful interference in a residential installation. This equipment generates, uses, and can radiate radio frequency energy, and if not installed and used in accordance with the instruction manual, may cause harmful interference to radio communications. However, there is no guarantee that interference will not occur in a particular installation. However, if this equipment does cause interference to radio or television equipment reception, which can be determined by turning the equipment off and on, the user is encouraged to try to correct the interference by one or more of the following measures:

- Reorient or relocate the receiving antenna.
- Increase the separation between equipment and receiver.
- Connect the equipment to an outlet on a circuit different from that to which the receiver is connected.
- Consult the dealer or an experienced radio/television technician for help.
- Use a shielded and properly grounded I/O cable and power cable to ensure compliance of this unit to the specified limits of the rules.

This device complies with part 15 of the FCC rules. Operation is subject to the following two conditions: (1) this device may not cause harmful interference and (2) this device must accept any interference received, including interference that may cause undesired operation.

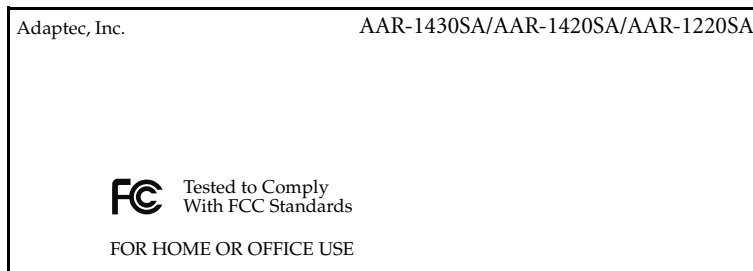

European Union Compliance Statement

This Information Technology Equipment has been tested and found to comply with EMC Directive 89/336/EEC, as amended by 92/31/EEC and 93/68/EEC, in accordance with:

- EN55022 (1998+A1:2000+A2:2003) Emissions
- EN55024 (1998+A1:2001+A2:2003) Immunity:
 - EN61000-4-2 (1995) Electrostatic discharge: ±4 kV contact, ±8 kV air
 - EN61000-4-3 (1996) Radiated immunity
 - EN61000-4-4 (1995) Electrical fast transients/burst: ±1 kV AC, ±0.5 kV I/O
 - EN61000-4-5 (1995) Surges ±1 kV differential mode, ±2 kV common mode
 - EN61000-4-6 (1996) Conducted immunity: 3 V
 - EN61000-4-11 (1994) Supply dips and variation: 30% and 100%

In addition, all equipment requiring U.L. listing has been found to comply with EMC Directive 73/23/EEC as amended by 93/68/EEC in accordance with EN60950 with amendments A1, A2, A3, A4, A11.



Australian/New Zealand Compliance Statement

This device has been tested and found to comply with the limits for a Class B digital device, pursuant to the Australian/New Zealand standard AS/NZS 3548 set out by the Spectrum Management Agency.



Canadian Compliance Statement

This Class B digital apparatus meets all requirements of the Canadian Interference-Causing Equipment Regulations.
Cet appareil numérique de la classe B respecte toutes les exigences du Règlement sur le matériel brouilleur du Canada.



Japanese Compliance (Voluntary Control Council Initiative)

This equipment complies to class B Information Technology equipment based on VCCI (Voluntary Control Council for Interface). This equipment is designed for home use but it may causes radio frequency interference problem if used too near to a television or radio. Please handle it correctly per this documentation.

Contents

About This Guide

What You Need to Know Before You Begin	11
Terminology Used in this Guide	11
How to Find More Information.....	11

About Your HostRAID Controller

HostRAID Controller Features	13
Array Level Features	13
Upgrading the HostRAID Controller Firmware	13
About the Adaptec 1430SA Controller	14
About the Adaptec 1420SA Controller	15
About the Adaptec 1220SA Controller	16

Kit Contents and System Requirements

Kit Contents	18
System Requirements.....	18

Getting Started

Choosing a RAID Level.....	20
Selecting Disk Drives	20
Disk Drives for Your Controller	20
Selecting Cables.....	20
SATA Cables.....	20
Installation Options	21
Basic Installation Steps	21
Installing with an Operating System.....	21
Installing on an Existing Operating System	21

Installing the HostRAID Controller and Disk Drives

Before You Begin.....	23
Installing the HostRAID Controller.....	23
Connecting Disk Drives to SATA HostRAID Controllers.....	24
Checking Your Controller and Devices	24
Determining the Boot Controller.....	24
Next Steps.....	24

Creating a Bootable Array

Setting the Boot Controller	26
Creating an Array.....	26
Creating an Array with the ACU.....	26
Creating an Array with Adaptec Storage Manager.....	27
Making Your Array Bootable	28

Installing the Driver and an Operating System

Before You Begin.....	30
Creating a Driver Disk.....	30
Installing with Windows.....	30
Installing with Red Hat Linux	31
Installing with SUSE Linux.....	31
Installing with NetWare.....	32

Installing the Driver on an Existing Operating System

Before You Begin.....	34
Creating a Driver Disk	34
Installing on Windows.....	34
Installing on Red Hat or SUSE Linux	35
Installing on NetWare.....	35

Managing Your Storage Space

About Adaptec Storage Manager	37
Installing Adaptec Storage Manager	37
About the HRCNF Command Line Utility	37
About the ARC Utility	38
About the AFU	38
Which Utility Should I Use?	38

Understanding Adaptec Storage Manager

Features.....	40
Overview.....	40
Physical Devices View.....	41
Logical Devices View	41
Changing How Drives are Displayed	41
Collapsed and Expanded Views	42
Component Views.....	43

Solving Problems

Troubleshooting Checklist	45
Recovering from a Disk Drive Failure	45
Failed Disk Drive Protected by a Hot Spare	45
Failed Disk Drive <i>Not</i> Protected by a Hot Spare	46
Failure in Multiple Arrays Simultaneously.....	46
Disk Drive Failure in a RAID 0 Array	46
Multiple Failures in the Same Array	46

Understanding RAID

RAID Technology Overview.....	48
Understanding Drive Segments	48
Stripe-unit Size.....	48
Selecting a RAID Level and Tuning Performance.....	48
RAID 0 (Non-RAID Arrays)	49
RAID 1 Arrays	50
RAID 10 Arrays	50

Using the ARC Utility

Introduction to the ARC Utility.....	52
Running the ARC Utility	52
Creating and Managing Arrays	52
Creating a New Array	52
Managing Arrays.....	54
Adding/Deleting Hotspares.....	56
Managing Bootable Arrays and Devices	56
Configuring Disk Drives.....	56
ATAPI Support	57
Using SATASelect.....	57
SATASelect Options	58
Formatting and Verifying Disk Drives.....	59

Using the AFU for DOS

Introduction	61
System Requirements	61
Compatibility	61
Running the AFU from the GUI	62
Running the AFU from the Command Line	62
HELP	62
LIST	62
SAVE.....	63
UPDATE.....	64
VERIFY.....	64
VERSION	65
Command Switches	65
AFU Command Line – Step-by-Step	65

Safety Information

Electrostatic Discharge (ESD)	67
-------------------------------------	----

Technical Specifications

Environmental Specifications.....	69
DC Power Requirements	69
Current Requirements	69

Glossary**Index**

About This Guide

1

In this chapter...

What You Need to Know Before You Begin	11
Terminology Used in this Guide.....	11
How to Find More Information	11

This *Installation and User's Guide* explains how to install your Adaptec® Serial ATA controller. It also describes the utilities included in your controller kit, and provides a basic overview of Serial ATA technology.

These HostRAID controller models are described in this Guide:

- Adaptec 1430SA, see [page 14](#)
- Adaptec 1420SA, see [page 15](#)
- Adaptec 1220SA, see [page 16](#)

What You Need to Know Before You Begin

You should be familiar with computer hardware, data storage, Redundant Array of Independent Disks (RAID) technology, and the input/output (I/O) technology—SATA—used by your HostRAID controller.

You should also be familiar with Direct Attached Storage (DAS) and Storage Area Network (SAN) concepts and technology.

Terminology Used in this Guide

Because you can use your HostRAID controller to manage data storage in a variety of configurations from DAS to SAN, the generic term “storage space” is used to refer to controller(s) and disk drives being managed with Adaptec Storage Manager™ or the other utilities described in this *Guide*.

Many of the terms and concepts referred to in this *Guide* are known to computer users by multiple names. This *Guide* uses these terms:

- Controller (also known as adapter, board, or card)
- Disk drive (also known as hard disk, hard drive, or hard disk drive)
- Array (also known as a container or logical drive)

Note: The *Adaptec Storage Manager User's Guide* refers to arrays as logical drives. Why? Your HostRAID controller creates *arrays*, which your operating system (and Adaptec Storage Manager) recognizes as *logical drives*.

How to Find More Information

You can find more information about your HostRAID controller and the software and utilities included with it by referring to these documents:

- *Readme.txt*—Includes updated product information and known issues; located on the HostRAID Installation CD.
 - *Adaptec Storage Manager User's Guide*—Describes how to install and use the Adaptec Storage Manager software (see [page 36](#)); located on the Adaptec Storage Manager Installation CD.
 - *Adaptec Storage Manager online Help*—Describes how to use the Adaptec Storage Manager software; accessible from the main window of Adaptec Storage Manager.
-

About Your HostRAID Controller

2

In this chapter...

HostRAID Controller Features	13
Upgrading the HostRAID Controller Firmware.....	13
About the Adaptec 1430SA Controller.....	14
About the Adaptec 1420SA Controller.....	15
About the Adaptec 1220SA Controller.....	16

This chapter provides an overview of standard HostRAID controller features, and describes the unique features of your SATA HostRAID controller. It also explains how to upgrade your controller with enhanced features.

HostRAID Controller Features

- Flash ROM for updates to controller firmware Adaptec Flash Utility (AFU), BIOS, and the Array Configuration Utility (ACU).
- Event logging and broadcasting, including messaging for alphanumeric pagers.
- Support for Adaptec Metadata Format (AMF) allowing the migration of simple volumes and arrays to Adaptec RAID controller cards.
- Multiple options for creating and managing RAID arrays—A full software application (Adaptec Storage Manager), a BIOS-based utility, a command line utility, and a DOS utility. See *Managing Your Storage Space on page 36* for more information.
- Support for disk drive hot swapping.
- Support for disk drive enclosures with SAF-TE enclosure management hardware.

Array Level Features

Note: For more information, refer to the *Adaptec Storage Manager User's Guide* or online Help.

- Support for RAID 0, 1, 10, and simple volume.
- Hot swap rebuild of fault tolerant arrays through the operating system.
- Support for automatic failover, so arrays are automatically rebuilt when a failed disk drive is replaced (applies to redundant arrays in SES- or SAF-TE-enabled disk drive enclosures only).
- Global hot spare protecting every fault tolerant array that the drive has enough available capacity to protect.
- Support for RAID 0 migration.

Upgrading the HostRAID Controller Firmware

To upgrade the firmware on your HostRAID controller, see *Using the AFU for DOS on page 60*.

About the Adaptec 1430SA Controller

The Adaptec 1430SA is a low-profile 4-port PCIe SATA II HostRAID controller with these features:

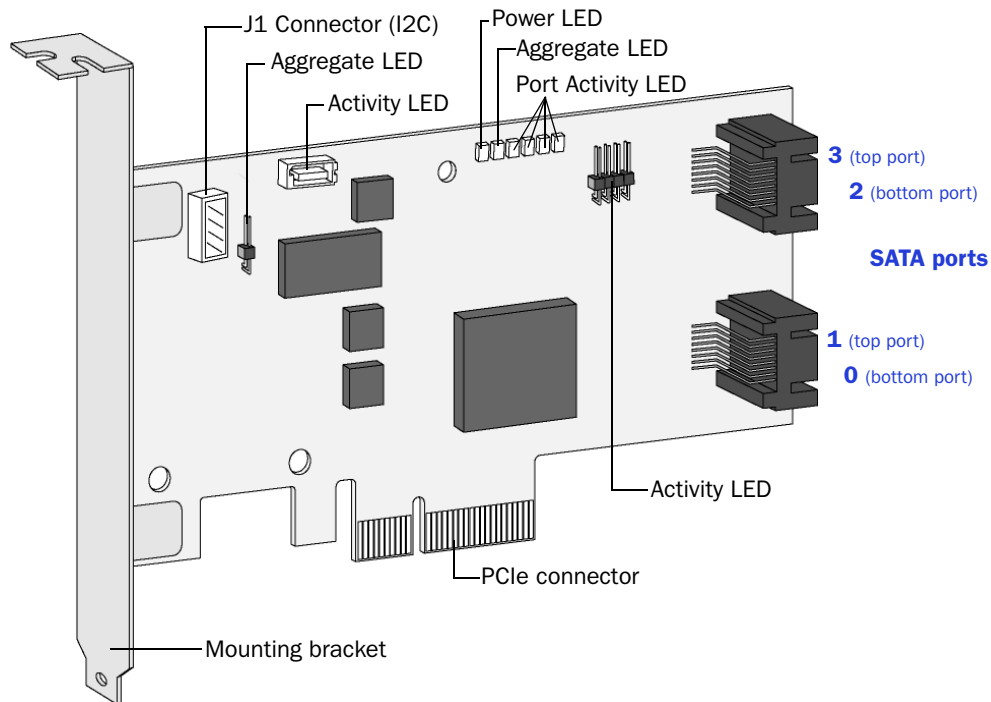

Form factor	Low-profile
PCI compatibility	PCIe x4
Ports	4 stacked
Connectors	4 internal
RAID levels	0, 1, 10
Simple volume	Yes
Disk drives	SATA I (1.5Gbps), SATA II (3.0Gbps)
Maximum number of disk drives	4
Hot spares	Yes
Enclosure support	Yes, SATA II Enclosure Management using I2C connection
Native Command Queuing (NCQ)	Yes
Automatic failover	Yes
Audible alarm	No

About the Adaptec 1420SA Controller

The Adaptec 1420SA is a low-profile PCI-X to 4 port SATA II HostRAID controller with these features:

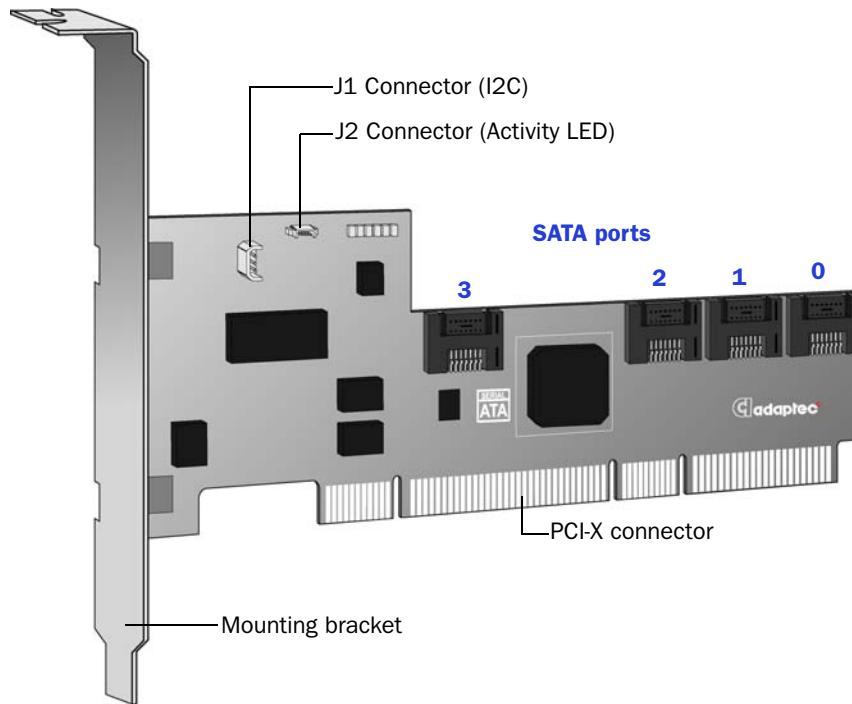

Form factor	Low-profile
PCI compatibility	PCI-X x1
Ports	4
Connectors	4 internal
RAID levels	0, 1, 10
Simple volume	Yes
Disk drives	SATA I (1.5Gbps), SATA II (3.0Gbps)
Maximum number of disk drives	4
Hot spares	Yes
Enclosure support	Yes, SATA II Enclosure Management using I2C connection
Native Command Queuing (NCQ)	Yes
Audible alarm	No

About the Adaptec 1220SA Controller

The Adaptec 1220SA is a low-profile PCIe to 2 port SATA II HostRAID controller with these features:

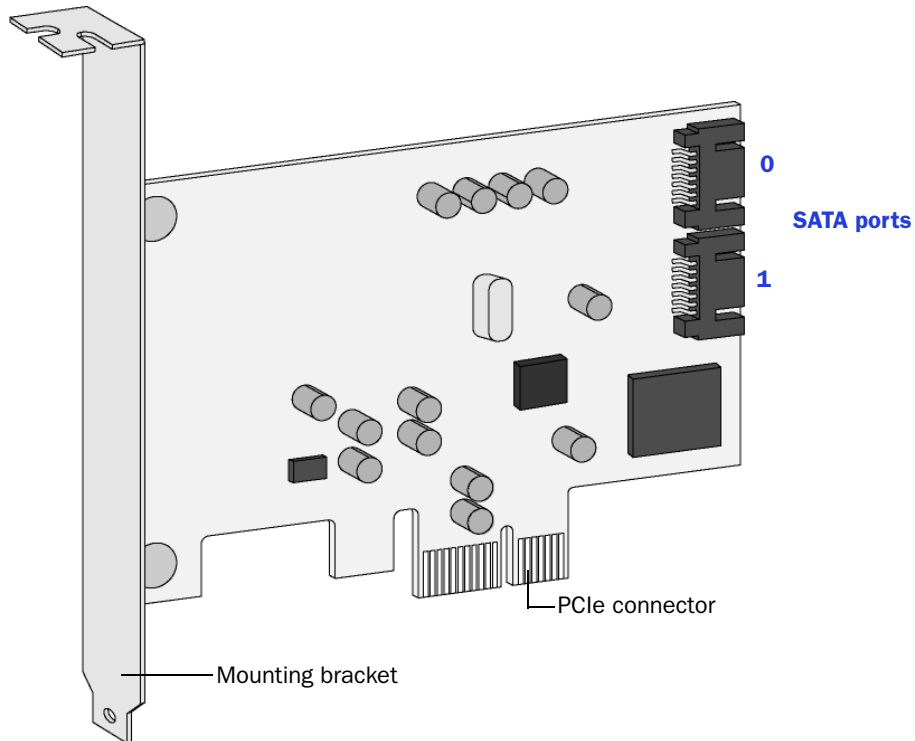

Form factor	Low-profile
PCI compatibility	PCIe
PCI bus width (max)	64-bit
PCI bus speed (max)	133 MHz
Ports	2
Connectors	2 internal
RAID levels	0, 1
Simple Volume	Yes
Disk drives	SATA I (1.5Gbps), SATA II (3.0Gbps)
Maximum number of disk drives	2
Hot spares	Yes
Enclosure support	No
Native Command Queuing (NCQ)	Yes
Audible alarm	No

Kit Contents and System Requirements

3

In this chapter...

Kit Contents.....	18
System Requirements	18

This chapter lists the contents of your HostRAID controller kit and the system requirements that must be met for you to successfully install and use your controller.

Kit Contents

- Adaptec SATA HostRAID controller
- HostRAID Installation CD (bootable), including controller drivers, and this *Guide*
- Adaptec Storage Manager Installation CD (not bootable), including user guides for Adaptec Storage Manager and the Adaptec HRCNF (HostRAID Configuration) command line utility
- Readme Files
- Cables (type and quantity vary for cable information about your HostRAID controller, see [About Your HostRAID Controller on page 12](#))
- Low-profile bracket
- *Serial ATA II 1430SA, 1420SA, 1220SA HostRAID Controllers Quick Start Guide*

System Requirements

- PC-compatible computer with Intel Pentium, or equivalent, processor
 - A motherboard with these features:
 - Complies with the PCI Local Bus Specification, Revision 2.2 and higher.
 - Supports multifunction devices where one of the devices is a PCI bridge.
 - Large memory-mapped address ranges.
 - One of these operating systems:
 - Microsoft® Windows®2000, Server 2003, XP
 - Red Hat Linux
 - SUSE Linux
 - Novell® NetWare®

Note: For up-to-date operating system version support, refer to the Adaptec Web Site at www.adaptec.com.
 - At least 256 MB (or more) of RAM
 - Available compatible PCI/PCI-X/PCIe slot (depending on your controller model-see [About Your HostRAID Controller on page 12](#))
 - 40 MB of free drive space
 - 16-bit SVGA color monitor with a resolution of at least 800 x 600
 - CD drive (that is not part of the HostRAID you are installing)
 - SATA interface cables
-

Getting Started

4

In this chapter...

Choosing a RAID Level.....	20
Selecting Disk Drives.....	20
Selecting Cables	20
Installation Options	21

This chapter provides the basic information you need to set up your disk drives and arrays the way you want them. It also describes the options you have for installing your HostRAID controller and disk drives, and creating arrays for data storage.

Note: Before you begin, familiarize yourself with your HostRAID controller's physical features and the RAID levels that it supports (see [page 12](#)).

Choosing a RAID Level

This section provides a brief overview of the RAID levels supported by your HostRAID controller, including the minimum and maximum number of disk drives required by each.

RAID 0 (Non-redundant Array)—Stripes data across multiple disk drives. Improved performance but no redundancy (see [page 49](#)).

RAID 1 Array—Created from two disk drives where one disk drive is a mirror of the other (the same data is stored on each disk drive). Redundancy, but reduced capacity (see [page 50](#)).

RAID 10 Array—Built from two or more equal-sized RAID 1 arrays, stripes and mirrors data across multiple disk drives. Redundancy and improved performance (see [page 50](#)). Not supported on the 1220SA controller.

Use the table on [page 49](#) to see how many disk drives you must connect to your HostRAID controller to support the RAID level you want.

Selecting Disk Drives

When selecting disk drives for your RAID array, ensure that all the disk drives have the same performance level. You can use different-sized disk drives in the array, but the array will be limited to the capacity of the smallest and slowest disk drive.

For more information, refer to the *Adaptec Storage Manager User's Guide* or Adaptec Storage Manager online Help.

Disk Drives for Your Controller

Your SATA controller supports both SATA (Serial ATA) I and II disk drives. For cable information, see next section.

Selecting Cables

This section describes the cable options and requirements for your HostRAID controller.

SATA Cables

You need one straight connector to straight connector SATA cable for each disk drive you are connecting to your Adaptec SATA RAID controller. SATA cables are included in the kit.



All SATA straight connector to straight connector cables have the same connectors, as shown in the following figure, and the connectors are keyed so that you can't insert them incorrectly.

Adaptec recommends using only Adaptec SATA cables. For more information or to purchase cables, visit the Adaptec Web site at www.adaptec.com.

Installation Options

When you install your HostRAID controller, you can choose to create a bootable array and then install your operating system and the controller driver on that array.

Alternatively, you can complete a standard installation, where the controller driver is installed on an existing operating system.

Basic Installation Steps

This section describes the installation process. Follow the steps for the installation option you've chosen.

Installing with an Operating System

- 1 Install and connect your controller and internal disk drives (see [page 22](#)).
- 2 Set the boot controller (see [page 26](#)).
- 3 Create a bootable array (see [page 25](#)).
- 4 Install your operating system and the driver (see [page 29](#)).
- 5 Install Adaptec Storage Manager and begin to manage your data storage (see [page 36](#)).

Installing on an Existing Operating System

- 1 Install and connect your controller and internal disk drives (see [page 22](#)).
If your controller has an external connector, you can connect external disk drives as well (or instead).
 - 2 Install the controller driver (see [page 34](#)).
 - 3 Install Adaptec Storage Manager and begin to manage your data storage (see [page 36](#)).
-

Installing the HostRAID Controller and Disk Drives

5

In this chapter...

Before You Begin	23
Installing the HostRAID Controller	23
Connecting Disk Drives to SATA HostRAID Controllers.....	24
Checking Your Controller and Devices.....	24
Determining the Boot Controller.....	24
Next Steps	24

This chapter explains how to install your HostRAID controller, and how to install and connect internal and external disk drives.

Before You Begin

- Read the Safety Information on [page 67](#).
- Familiarize yourself with your HostRAID controller's physical features and the RAID levels that it supports (see [page 12](#)).
- Ensure that you have the right quantity of disk drives for the RAID level you want to use for your arrays (see [page 47](#)).
- Ensure that you have the proper cables for your controller and disk drives (see [page 12](#)).
- If you have a low-profile computer cabinet, replace the original full-height bracket with the low-profile bracket supplied in the controller kit.

 **Caution:** Handle the controller by its bracket or edges only.

Installing the HostRAID Controller

This section describes how to install your HostRAID controller into your computer cabinet.

- 1 Turn off your computer and disconnect the power cord. Open the cabinet, following the manufacturer's instructions.

- 2 Select an available PCI or PCI-X expansion slot and remove the slot cover, as shown at right. (see [page 12](#).)

For the best performance, use the available 64-bit slot that's compatible with your HostRAID controller.

 **Caution:** Touch a grounded metal object before handling the HostRAID controller.

- 3 As shown at right, insert the HostRAID controller into the PCI or PCI-X expansion slot and press down gently but firmly until it clicks into place. When installed properly, the HostRAID controller should appear level with the expansion slot.

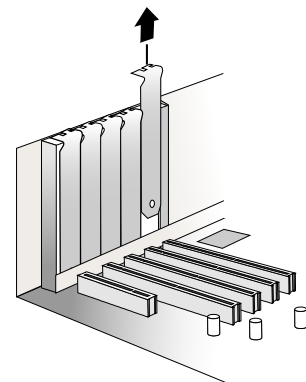

- 4 Secure the bracket in the PCI slot, using the retention device (for instance, a screw or lever) supplied with your computer.
- 5 Connect your computer's disk activity LED cable to the LED connector on the controller (see [page 12](#)).

Ensure that the positive lead of the LED cable (usually a red wire or a wire marked with a red stripe) is attached to pin 1.

- 6 **Optional**—Connect your HostRAID controller's I2C connector (not available on all models) to an I2C connector on an internal backplane or enclosure, using an I2C cable.

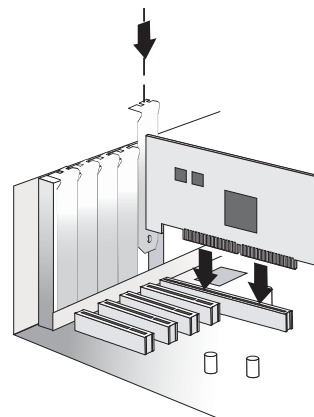

- 7 Install your disk drives, following the instructions on [page 24](#).

Connecting Disk Drives to SATA HostRAID Controllers

You can connect SATA disk drives to your HostRAID controller. There are no jumpers or switches to set before installation. The cable ends are identical, so you don't need to worry about which end to attach to the controller and which end to attach to the drive.

The interface cable connectors, controller connectors, and disk drive connectors are all keyed so that you can insert them in only one direction.

If you plan to build a bootable array using internal disk drives, ensure you install at least the minimum number disk drives required to support the RAID level you want. See [page 47](#) for more information.

Checking Your Controller and Devices

Now that you have installed your controller and connected your Serial ATA disk drives, you are ready to use the ARC utility to check your controller and devices, as described below:

- 1 Turn on your computer.
- 2 When the Adaptec banner appears, enter the ARC utility by pressing Ctrl+A.
- 3 If your drives have already been used in another system (even if not part of an array), select Disk Utilities and format the drive. Otherwise, skip to Step 4.

Note: If a drive appears to be missing, power down the computer and check the connections.

- 4 Select SATASelect to verify the hardware configuration of the controller and the drives.

Verify that all drives and controllers are shown. If anything appears to be missing, power down the computer and check the connections.

Determining the Boot Controller

Your Adaptec Serial ATA II RAID 1430SA, 1420SA, and 1220SA are bootable controllers. If your computer already contains a bootable disk drive with an installed operating system, you can set up your computer to boot a second operating system from the new controller.

To add a second bootable controller, you may need to enter Setup and change the hard disk boot sequence so that the Adaptec Serial ATA II RAID controller heads the list. If Setup does not allow this change, your system BIOS may not be configurable to allow the Adaptec Serial ATA II RAID controller to act as a second boot device.

Next Steps

If you are installing the driver and an operating system onto a bootable array, continue with [Creating a Bootable Array on page 25](#).

If you are completing a standard installation onto an existing operating system, continue with [Installing the Driver on an Existing Operating System on page 33](#).

6

Creating a Bootable Array

In this chapter...

Setting the Boot Controller.....	26
Creating an Array	26
Creating an Array with the ACU	26
Creating an Array with Adaptec Storage Manager	27
Making Your Array Bootable	28

This chapter explains how to set your HostRAID controller to be the boot controller, and how to create a bootable array.

Note: If you are completing a standard installation onto an existing operating system, you don't have to complete this task. Skip to [Installing the Driver on an Existing Operating System](#) on page 33.

Setting the Boot Controller

Note: If your system won't contain more than one bootable controllers, skip this section.

Adaptec HostRAID controller supports bootable disk drives and arrays. The default setting of the HostRAID controller and system Setup allows you to install and boot from either a disk drive connected to the motherboard, or from a drive or array connected to the HostRAID controller. To enable the system to boot from either a disk drive or an array connected to the HostRAID controller:

Note: Selecting the boot controller is done under the system BIOS Setup Utility. Launching the system BIOS Setup Utility varies, see the system BIOS user's manual for more information.

- 1 Enter the system BIOS Setup.
- 2 Navigate to the disk drive boot sequence.
- 3 Move the boot controller to the top of the list.

Creating an Array

You can create a RAID 0, 1, or 10 array using one of these tools:

- **Array Configuration Utility (ACU)**—BIOS-based menus and keyboard navigation (see [page 51](#)).
- **Adaptec Storage Manager**—Graphical software application (running from a bootable CD) that you can navigate with your mouse (see [page 37](#)).

You can use either tool, but the ACU is the quicker and easier tool for this task.

Creating an Array with the ACU

The ACU is menu-based and instructions for completing tasks display on-screen. Menus can be navigated using the arrows, Enter, Esc, and other keys on your keyboard.

Before creating arrays, make sure the disks for the array are connected and installed in your system. Disks with no usable space are shown in gray and cannot be used. See [Physical Devices View on page 41](#).

To create an array:

- 1 Turn on your computer and press **Ctrl+A** when prompted to access the ARC utility.
- 2 From the ARC menu, select **Array Configuration Utility (ACU)**.
- 3 From the ACU Main menu, select **Create Array**.
- 4 Select the disks for the new array. RAID 0 and 1 requires a minimum of two disk drives. RAID 10 requires a minimum of four disk drives. Then press **Insert**.

To deselect any disk, highlight the disk, then press **Delete**.

- 5 Press **Enter** when all disks for the new array are selected. The Array Properties menu displays. For Array Property Information see [Assigning Array Properties on page 52](#)
- 6 When you are finished, press **Done**.

Creating an Array with Adaptec Storage Manager

This section describes how to use the Adaptec Storage Manager configuration wizard to build a RAID 0, 1, or 10 array.

Note: You will need the HostRAID Installation CD to complete this task.

To create a RAID 0, 1, or 10 array:

- 1 Insert the HostRAID Installation CD into your CD drive, then restart your computer.
- 2 When prompted, select the language you want, then press **Enter**.
- 3 Review the license information, then press **Enter**.

The Main Menu opens.

- 4 Click **Launch Configuration Utility**.

Adaptec Storage Manager opens.

- 5 Click **Create**.

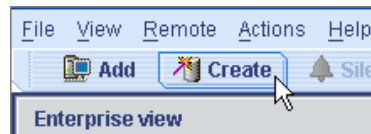

The Configuration wizard opens.

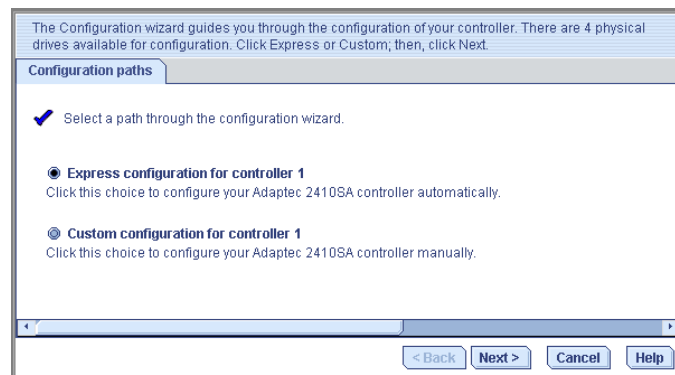

- 6 Select **Express configuration...**, then click **Next**.

- Review the information that is displayed.

Note: Adaptec Storage Manager uses the term logical drives when referring to arrays (see [page 11](#)).

In the following figure, Adaptec Storage Manager has used two equal-sized disk drives to automatically create one logical drive with RAID 1.

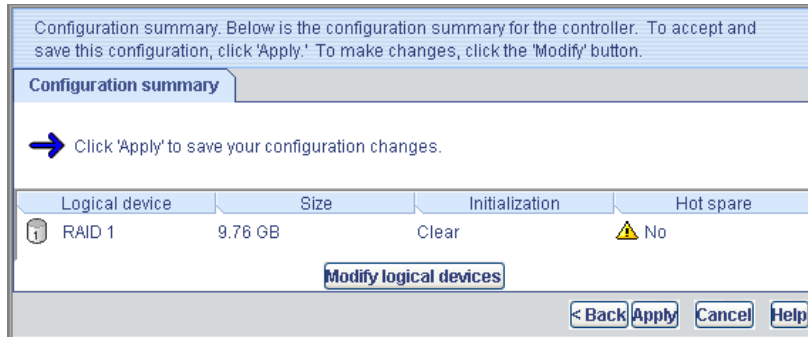

To specify a size for the logical drives, or to make other changes to the configuration, click **Modify logical devices**.

- Click **Apply**, then click **Yes** when prompted to confirm applying your new configuration.

Adaptec Storage Manager builds the logical drive(s).

The configuration is saved on the Adaptec controller (as an “array;” see [page 11](#)) and on the physical disk drives.

- Partition and format your logical drive.

The logical drive you created appears as a physical disk drive on your operating system. You must partition and format these logical drives before you can use them to store data.

- Close all windows, then click **Reboot** to restart your system.

- Remove the HostRAID Installation CD.

For information on installing and using Adaptec Storage Manager as a full software application, refer to the online Help or the *Adaptec Storage Manager User's Guide*.

- Continue with [Making Your Array Bootable](#) (see next section).

Making Your Array Bootable

Use the ACU to make the array bootable (see [Managing Bootable Arrays and Devices on page 56](#)).

Then continue with [Installing the Driver and an Operating System on page 29](#).

Installing the Driver and an Operating System

7

In this chapter...

Before You Begin	30
Creating a Driver Disk	30
Installing with Windows	30
Installing with Red Hat Linux	31
Installing with SUSE Linux.....	31
Installing with NetWare	32

This chapter explains how to install your HostRAID controller driver and an operating system onto a bootable array (see [page 25](#)).

Note: To install the driver on an existing operating system, see [page 33](#).

Before You Begin

- Install and connect your HostRAID controller and internal disk drives (see [page 22](#)).
- Create a bootable array (see [page 25](#)).
- Create a driver disk (see next section).

Creating a Driver Disk

Before you install your driver, you will need to create a driver disk. You will need a floppy disk to complete this task. To create a driver disk:

- 1 Set your system BIOS so that your computer boots from the CD drive. (For instructions, refer to your computer's documentation.)
- 2 Click **Create Driver Disk**, from the Main Menu.
- 3 Select one of the operating systems from the list:
 - Windows
 - Linux
 - Netware
- 4 Select the type of operating system you want to use.
- 5 Select the version of the operating system.
- 6 When prompted, insert a floppy disk, then click **OK**.
The system creates the driver disk.
- 7 Remove and label the driver disk.
- 8 Continue with the instructions for your operating system:
 - For Windows, see next section.
 - For Red Hat Linux, see [page 31](#).
 - For SUSE Linux, see [page 31](#).
 - For NetWare, see [page 32](#).

Installing with Windows

You will need your Windows Installation CD to complete this task. To install the HostRAID controller driver while installing Windows:

- 1 Insert your Windows CD, then restart the computer.
- 2 Follow the on-screen instructions to begin the Windows installation.
- 3 When prompted to install a third-party driver, press **F6**.

Note: When **F6** is active, a prompt appears at the bottom of the screen for only 5 seconds. If you miss your chance to press **F6**, restart your computer.

- 4 Insert the driver disk, then wait until you are prompted to install a driver.
- 5 Press **S** to specify that the driver is on a floppy disk, then press **Enter**.
The computer reads the disk.
- 6 When the Adaptec SATA driver is found, press **Enter**.
- 7 Follow the on-screen instructions to complete the installation.
- 8 Continue with [Managing Your Storage Space on page 36](#).

Installing with Red Hat Linux

You will need your Red Hat Installation CD to complete this task. To install the HostRAID controller driver while installing Red Hat Linux:

- 1 Insert the first Red Hat Installation CD.
- 2 Restart your computer.
- 3 When the Red Hat Welcome screen displays, type `linux dd` at the **Boot:** prompt.
- 4 When prompted, insert the driver disk, then select **OK**.
- 5 Follow the prompts to set up the environment you want.
- 6 If you are installing other third-party devices, install them now. Otherwise, select **Done**.
- 7 Complete the Red Hat Linux installation, following the instructions included with your operating system.
- 8 Continue with [Managing Your Storage Space on page 36](#).

Installing with SUSE Linux

To install the HostRAID controller driver while installing SUSE Linux:

- 1 Insert the first SUSE Installation CD.
- 2 Restart your computer.
- 3 When the SUSE installation selection screen displays, do the following:
 - For **UL 1.0**—press the **Alt** key to have it prompt for a driver disk, select installation option from the Menu, then press **Enter**.
 - For **SLES 9, SUSE 9.x and 10**—press the **F6** key, select installation option from the Menu, then press **Enter**.
- 4 When prompted, insert the driver disk, then press any key to continue.
- 5 Follow the prompts to set up the environment you want.
- 6 If you are installing other third-party devices, install them now. Otherwise, select **Back**.
- 7 Complete the SUSE Linux installation, following the instructions included with your operating system.
- 8 Continue with [Managing Your Storage Space on page 36](#).

Installing with NetWare

You will need your NetWare Installation CD to complete this task. To install the driver when installing NetWare:

- 1 Restart your computer, then install NetWare. (For instructions, refer to your NetWare documentation.)

To be able to load additional drivers later, select **Manual** install mode during the first part of the installation.
- 2 Click **Continue** to load additional drivers:
 - a Select **Modify** when the storage adapters are displayed.
 - b Select **Storage Adapters**, then press the **Insert** key twice to add an unlisted driver from the floppy disk.
- 3 When the Device Types screen displays, check the Storage adapters list, then select **Modify** to add another driver.
- 4 Select **Storage Adapters**, then press **Enter**.

All recognized controllers are displayed.
- 5 If necessary, remove the default HostRAID SATA driver (<*driver-name*>.ham).
- 6 Press the **Delete** key to remove it.
- 7 Press **Insert** to add another driver.

The available drivers are displayed.
- 8 Insert the driver floppy disk.
- 9 Press the **Insert** key to scan the floppy disk drive.

Once the driver is selected, the Parameter screen is displayed.
- 10 From the lower window menu, select **Continue**, then press **Enter**.

If the driver installation process fails, the server console is displayed so you can see the cause of the failure.

To modify disk partitions, apply hot fixes, or perform volume maintenance, refer to your NetWare documentation.
- 11 Continue with *Managing Your Storage Space* on page 36.

Installing the Driver on an Existing Operating System

8

In this chapter...

Before You Begin	34
Creating a Driver Disk	34
Installing on Windows	34
Installing on Red Hat or SUSE Linux.....	35
Installing on NetWare	35

This chapter explains how to install your HostRAID controller driver on an existing operating system.

Note: To install the driver while you're installing an operating system, see [page 29](#).

Before You Begin

Before you begin, install and connect your HostRAID controller and internal disk drives (see [page 22](#)).

You must also create a driver disk (see next section) before you begin installing the controller driver.

Creating a Driver Disk

Before you install your driver, you will need to create a driver disk. You will need a floppy disk to complete this task. To create a driver disk:

- 1 Set your system BIOS so that your computer boots from the CD drive. (For instructions, refer to your computer's documentation.)
- 2 Turn on your computer, then insert the HostRAID Installation CD included in your controller kit.
- 3 Follow the on-screen instructions to get to the Adaptec Start Menu.
- 4 Click **Create Driver Disk**, from the Main Menu.
- 5 Select one of the operating systems from this list:
 - Windows
 - Linux
 - Netware
- 6 Select the type of operating system you want to use.
- 7 Select the version of the operating system.
- 8 When prompted, insert the floppy disk, then click **OK**.
The system creates the driver disk.
- 9 Remove and label the driver disk.
- 10 Continue the driver installation for your operating system:
 - For Windows, see next section.
 - For Red Hat or SUSE Linux, see [page 35](#).
 - For NetWare, see [page 35](#).

Installing on Windows

To install the driver on Windows:

- 1 Start or restart Windows.
The Found New Hardware Wizard opens and searches for the driver.
 - 2 Insert the driver disk, select **Floppy drive**, then click **Next**.
 - 3 Click **Next**, then click **Next** again.
 - 4 Follow the on-screen instructions to complete the driver installation.
 - 5 Remove the driver disk and restart your computer.
-

- 6 Continue with *Managing Your Storage Space* on page 36.

Installing on Red Hat or SUSE Linux

To install the module on Red Hat or SUSE Linux:

- 1 Insert and mount the RAID Installation CD:

```
Red Hat—mount /dev/cdrom /mnt/cdrom
SUSE—mount /dev/cdrom /media/cdrom
UL 1.0—mkdir /mnt/cdrom /mnt/cdrom
```

- 2 Install the module RPM:

```
rpm -Uvh mount-point/xxx/yyy.rpm
```

where `mount-point` is the specific mount point on the Linux system, `xxx` is the driver path, and `yyy.rpm` is the rpm file.

- 3 Run `fdisk`, `mkfs`, and create mount points for any new disk drives.
- 4 Continue with *Managing Your Storage Space* on page 36.

Installing on NetWare

Note: Before you begin, ensure that your NetWare operating system has been upgraded to the minimum patch level specified by Novell. Refer to the Novell Web site for more information.

To install the driver on NetWare:

- 1 Start your computer.
- 2 From the NetWare server console prompt, type `load hdetect`, then press **Enter**.
- 3 From the Device types menu, select **Continue**, then press **Enter**.
- 4 From the Device type option, select **Modify**, then press **Enter**.
- 5 Select **Storage Adapters**, then press **Enter**.
- 6 From the Additional Driver Options menu, select **Modify**, then press **Enter**.
- 7 From the Driver Name menu, press the **Insert** key.
- 8 Insert the driver disk, press the **Insert** key, then press **F3**.
- 9 From the A:\ prompt, press **Enter**.
The driver installs.
- 10 From the Additional Driver Option menu, select **Return to driver summary**, then press **Enter**.
- 11 From the Driver type menu, select **Load on Additional Driver Options**.
- 12 After the driver loads, select **Continue**.
- 13 Continue with *Managing Your Storage Space* on page 36.

Managing Your Storage Space

9

In this chapter...

About Adaptec Storage Manager	37
Installing Adaptec Storage Manager.....	37
About the HRCONF Command Line Utility.....	37
About the ARC Utility.....	38
About the AFU	38
Which Utility Should I Use?	38

Once you have installed your HostRAID controller, disk drives (or other devices), and device driver, you can begin to build and manage your storage space.

This chapter introduces Adaptec Storage Manager, and describes the other utilities included with your HostRAID controller.

About Adaptec Storage Manager

Adaptec Storage Manager is a full-featured software application that helps you build a storage space for your online data, using HostRAID controllers and disk drives.

With Adaptec Storage Manager, you can group disk drives into logical drives and build in redundancy to protect your data and improve system performance.

You can also use Adaptec Storage Manager to monitor and manage all the controllers and disk drives in your storage space from a single location.

When Adaptec Storage Manager is installed on a computer, the *Adaptec Storage Manager agent* is also installed automatically. The agent is like a service that keeps your storage space running. It's designed to run in the background, without user intervention, and its job is to monitor and manage system health, event notifications, tasks schedules, and other on-going processes on that system. It sends notices when tasks are completed successfully, and sounds an alarm when errors or failures occur on that system.

The agent uses less memory than the full application. If your storage space includes systems that won't be connected to monitors (and therefore won't require the user interface), you can choose to run the *agent only* on those systems instead of the full application. For more information, refer to the *Adaptec Storage Manager User's Guide* or online Help.

Installing Adaptec Storage Manager

Adaptec Storage Manager is included on the Adaptec Storage Manager Installation CD. For installation instructions, refer to the *Adaptec Storage Manager User's Guide*, also included on the Adaptec Storage Manager Installation CD.

About the HRCNF Command Line Utility

HRCNF (HostRAID Configuration Utility) is a command line utility that you can use to perform some basic array and configuration management functions.

With HRCNF, you can:

- Create and delete logical drives
- Modify and copy configuration settings
- Recover from disk drive failures and troubleshoot

Installing and Using the Command Line Utility [on page 76](#), describes how to use HRCNF.

Note: Adaptec recommends that only advanced users familiar with command line interfaces use HRCNF.

About the ARC Utility

The Adaptec RAID Configuration (ARC) utility is a BIOS-based utility that you can use to create and manage controllers, disk drives and other devices, and arrays. The ARC utility comprises these tools:

- **Array Configuration Utility (ACU)**—For creating and managing arrays, and initializing and rescanning disk drives.
- **SATASelect Utility**—Used to change device and HostRAID controller settings.
- **Disk Utilities**—For formatting or verifying disk drives.

The ARC utility is included in your controller's BIOS. For more information, see [Using the ARC Utility on page 51](#).

Note: The ARC utility is primarily intended for pre-operating system installation configuration.

About the AFU

The Adaptec Flash Utility (AFU) is a text-based DOS utility that you can use to update, save, or verify your HostRAID controller's firmware BIOS and Non-Volatile Random Access Memory (NVRAM).

 **Caution:** Although the AFU contains safeguards to prevent you from accidentally damaging your HostRAID controller's flash contents, it is still important to use the AFU carefully and correctly to avoid rendering your HostRAID controller inoperable. Adaptec recommends that only advanced users familiar with working in DOS use the AFU.

Which Utility Should I Use?

To create a bootable array, Adaptec recommends that you use the BIOS-based ARC utility (see above).

For all subsequent storage management tasks, Adaptec recommends that you install and use Adaptec Storage Manager (see [page 37](#)). As a full-featured software application with a graphical user interface (GUI), it is the easiest to use and offers the widest range of management functions.

Understanding Adaptec Storage Manager

10

In this chapter...

Features	40
Overview	40
Changing How Drives are Displayed.....	41
Collapsed and Expanded Views.....	42
Component Views.....	43

This chapter provides an overview of Adaptec Storage Manager, the user-friendly GUI that you use to easily create and manage arrays. For more details on using Adaptec Storage Manager to set up and manage arrays, refer to the online Help.

Features

You can use Adaptec Storage Manager to:

- Create, verify, modify, and delete arrays
- Add and remove hot spares
- View the RAID configuration
- View information about managed systems and subsystems such as arrays, logical drives, hot-spare drives, physical drives
- Notify systems of all events occurring on the local system
- Add or remove a remote system

Overview

Adaptec Storage Manager provides an expandable tree view of the systems and controllers you are managing. You can perform most configuration and management tasks by selecting a controller from the tree and working with related objects. The figure below shows how Adaptec Storage Manager displays information about Physical and Logical devices.



Using the buttons in the Physical devices and Logical devices views, you can:

- Change how drives are displayed
- Collapse and expand a view
- Identify components of a logical device
- Create and delete hotspares

Physical Devices View

This view displays information about the drives, enclosures, and other physical devices attached to the controller. The devices are organized numerically. The display for each channel or port includes information on maximum speed, the number of the channels on the controller, and the number of devices attached to the controller.

Indicators, next to the controller name, report status of the fan and temperature modules on SAF-TE (enclosure management) devices and other devices that monitor these conditions. The indicator colors are:

- Blue—Normal
- Yellow—Warning
- Red—Error
- Gray—Not applicable to the devices.

For example, the fan indicator changes to yellow when one fan fails; it changes to red when a second fan fails and cooling is no longer adequate.

Logical Devices View

This view displays information about the logical devices created using the physical devices, including the number of logical devices, the RAID level of each device, and whether a logical device is protected by a hot spare.

You can create and delete logical devices in the Logical devices view by selecting the Create option and using the Create wizard.

Changing How Drives are Displayed

You can choose how information is displayed in the Physical devices view by clicking one of the following buttons in the Logical devices view.



Displays physical device information in text format. This is the default view.



Displays physical device information in full size capacity format. A full-length bar is displayed for each drive, regardless of capacity. A small segment on each drive is reserved for the RAID signature; this area is indicated by a gray cap at the end of each bar.

Note: Note: A drive shaded in light blue is not part of any disk group.



Displays physical device information in relative size capacity format. A full-length bar is displayed for the largest drive; proportionally shorter bars are displayed for other drives.

Collapsed and Expanded Views

You can display a collapsed or expanded view of the system configuration. Initially, Storage Manager displays a collapsed textual view of the configuration information in both the Logical devices and Physical devices views.

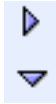

In the Logical devices view...

Click to expand and collapse information about disk groups and logical devices. The expanded display shows the following information about each logical device:

- Disk group name and capacity (if available)
- Logical device size
- Logical device state
- Build progress

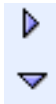

In the Physical devices view...

Click to expand and collapse information about physical drives. The expanded display shows the following information about each drive:

- Capacity of the drive
- Drive ID
- Drive state

Physical devices	Logical devices
Controller 1 (SATA HostRAID) 	
Direct-attached devices ▾ Port 0 - Optimal (9.766 GB) Port 1 - Optimal (9.766 GB) Port 2 - Optimal (9.766 GB) Port 3 - Hot spare (9.766 GB)	Logical devices (2) ▸
Connection status: Connected	

Component Views

When you click a physical or logical device in the device views, the related components are highlighted in the other view.

- When you click a logical device in the Logical devices view, the physical drives that make up the logical device are highlighted in the Physical devices view, and vice-versa.

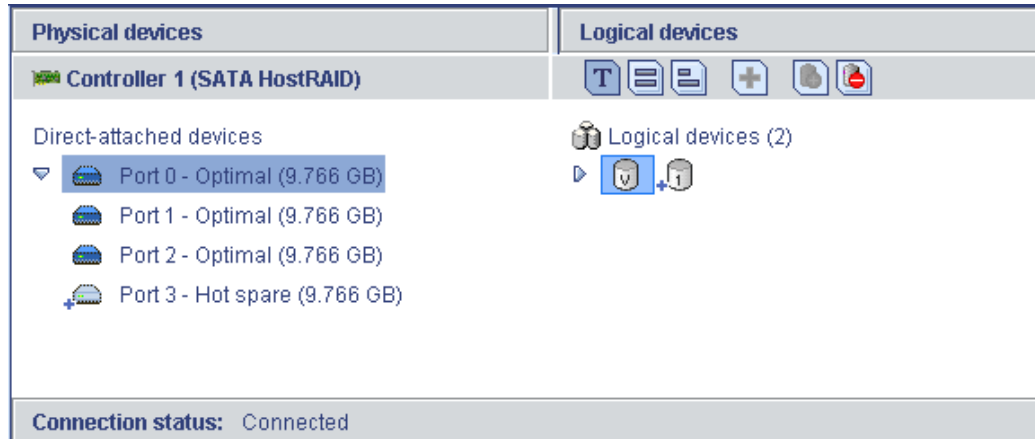

- When you click a hot spare, the logical devices protected by that spare are highlighted.

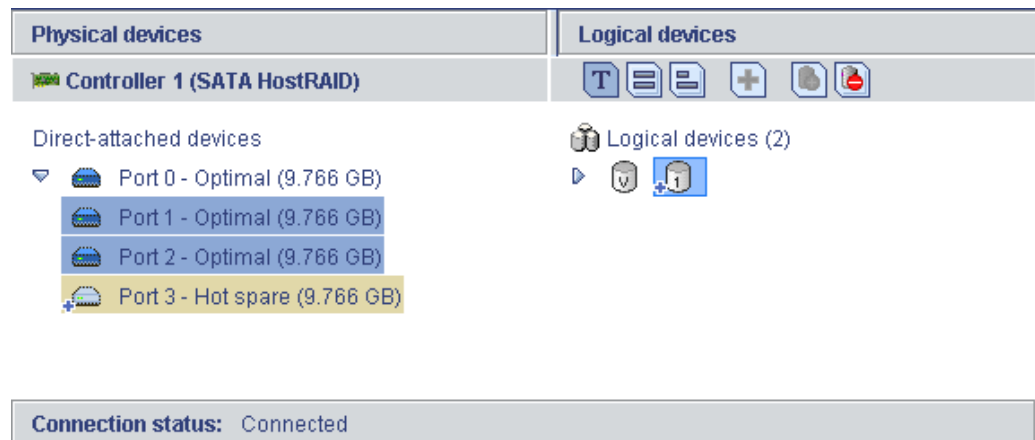

- In the graphical views, if the logical device uses only part of the available storage, only those segments are highlighted (in dark blue).

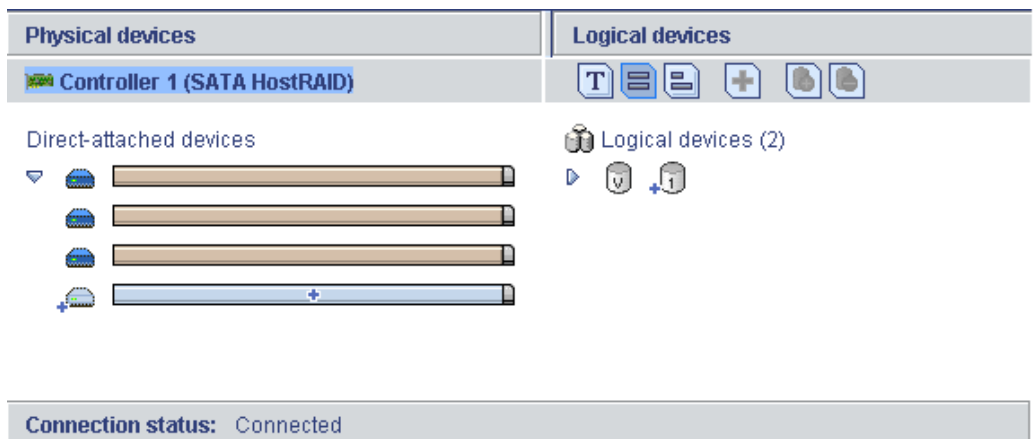

Solving Problems

11

In this chapter...

Troubleshooting Checklist	45
Recovering from a Disk Drive Failure	45

This chapter provides basic troubleshooting information and solutions for solving your HostRAID controller problems.

Troubleshooting Checklist

If you encounter difficulties installing or using your HostRAID controller, check these items first:

- With your computer powered off, check the connections to each disk drive, the power supply, the LED connector, and so on.
- Try disconnecting and reconnecting disk drives from the HostRAID controller.
- Check that your HostRAID controller is installed in a compatible expansion slot (PCI-X). To double-check the bus compatibility of your controller, see [About Your HostRAID Controller on page 12](#).
- Ensure that your HostRAID controller is firmly seated and secured in the PCI-X expansion slot.
- If your HostRAID controller is not detected during system boot, try installing it in a different PCI-X expansion slot. (See [page 23](#) for instructions.)
- Did the driver install correctly?

If you are still unable to resolve a problem, you can find additional troubleshooting information and direction on the Adaptec Web site at www.adaptec.com and the Adaptec Support Knowledgebase at ask.adaptec.com.

Recovering from a Disk Drive Failure

This section explains how to recover when a disk drive fails:

- If the array was protected by a hot spare (see next section).
- If the array was *not* protected by a hot spare (see [page 46](#)).
- If there is a disk drive failure in more than one array simultaneously (see [page 46](#)).
- If it is a RAID 0 array (see [page 46](#)).
- If multiple disk drives fail within the same array (see [page 46](#)).

Note: Adaptec Storage Manager uses the term *logical drives* when referring to *arrays* (see [page 11](#)).

Failed Disk Drive Protected by a Hot Spare

When an array is protected by a hot spare, if a disk drive in that array fails the hot spare is automatically incorporated into the array and takes over for the failed drive.

To recover from the failure:

- Remove and replace the failed disk drive (following manufacturer's instructions).

Failed Disk Drive Not Protected by a Hot Spare

When an array is not protected by a hot spare, if a disk drive in that array fails, remove and replace the failed disk drive. The controller detects the new disk drive and begins to rebuild the array.

If the controller fails to rebuild the array, check that the cables, disk drives, and controllers are properly installed and connected. Then, if necessary, use Adaptec Storage Manager to rebuild the array. For instructions, refer to the *Adaptec Storage Manager User's Guide* or online Help.

Failure in Multiple Arrays Simultaneously

If there's a disk drive failure in more than one array at the same time (one failure per array), and the arrays have hot spares protecting them, the controller rebuilds the arrays with these limitations:

- A hot spare must be of equal or greater size than the failed disk drive it's replacing.
- Failed disk drives are replaced with hot spares in the order in which they failed. (The array that includes the disk drive that failed first is rebuilt first, assuming an appropriate hot spare is available—see bullet above.)

If there are more disk drive failures than hot spares, see [Failed Disk Drive Not Protected by a Hot Spare](#) in previous section.

Disk Drive Failure in a RAID 0 Array

Because RAID 0 volumes do not include redundancy, if a disk drive fails in a RAID 0 array, the data can't be recovered.

Correct the cause of the failure or replace the failed disk drives. Then, restore your data (if available).

Multiple Failures in the Same Array

If more than one disk drive fails at the same time in the same RAID 1 array, the data can't be recovered.

Correct the cause of the failure or replace the failed disk drives. Then, restore your data (if available).

In some instances, RAID 10 arrays *may* survive multiple disk drive failures, depending on which disk drives fail. For more information, refer to the *Adaptec Storage Manager User's Guide* or online Help.

Understanding RAID



In this chapter...

RAID Technology Overview	48
RAID 0 (Non-RAID Arrays).....	49
RAID 1 Arrays	50
RAID 10 Arrays	50

When you create arrays (or logical drives), you can assign a RAID level to protect your data.

Each RAID level offers a unique combination of performance and redundancy. RAID levels also vary by the number of disk drives they support.

This appendix describes the RAID levels supported by your HostRAID controller, and provides a basic overview of each to help you select the best level of protection for your data storage.

RAID Technology Overview

RAID is the technology of grouping several *physical* drives in a computer into an *array* that you can define as one or more logical drives. Each *logical* drive appears to the operating system as a single drive. This grouping technique greatly enhances logical-drive capacity and performance beyond the physical limitations of a single physical drive.

When you group multiple physical drives into a logical drive, the HostRAID controller can transfer data in parallel from the multiple drives in the array. This parallel transfer yields data-transfer rates that are many times higher than with non-arrayed drives, enabling the system to better meet the *throughput* (amount of data processed in a given amount of time) or productivity needs of the multiple-user network environment.

The ability to respond to multiple data requests provides not only an increase in throughput, but also a decrease in response time. The combination of parallel transfers and simultaneous responses to multiple requests enables disk arrays to provide a high level of performance in network environments.

Understanding Drive Segments

A drive segment is a disk drive or portion of a disk drive that is used to create an array. A disk drive can include both RAID segments (segments that are part of an array) and available segments. Each segment can be part of only one logical device at a time. If a disk drive is not part of any logical device, the entire disk is an available segment.

Stripe-unit Size

With RAID technology, data is *striped* across an array of physical drives. This data-distribution scheme complements the way the operating system requests data.

The granularity at which data is stored on one drive of the array before subsequent data is stored on the next drive of the array is called the *stripe-unit size*.

You can set the stripe-unit size to 16, 32, or 64 KB. You can maximize the performance of your HostRAID controller by setting the stripe-unit size to a value that is close to the size of the system I/O requests. For example, performance in transaction-based environments, which typically involve large blocks of data, might be optimal when the stripe-unit size is set to 32 or 64 KB. However, performance in file and print environments, which typically involve multiple small blocks of data, might be optimal when the stripe-unit size is set to 16 KB.

The collection of stripe units, from the first drive of the array to the last drive of the array, is called a *stripe*.

Selecting a RAID Level and Tuning Performance

Disk arrays are used to improve performance and reliability. The amount of improvement depends on the application programs that you run on the server and the RAID levels that you assign to the logical drives.

Each RAID level provides different levels of fault-tolerance (data redundancy), utilization of physical drive capacity, and read and write performance. In addition, the RAID levels differ in regard to the minimum and maximum number of physical drives that are supported.

When selecting a RAID level for your system, consider the following factors.

RAID Level	Data Redundancy	Physical Drive Capacity Utilization	Read Performance	Write Performance	Built-In Spare Drive	Min Number of Drives	Max Number of Drives
0	No	100%	Superior	Superior	No	1	4
1	Yes	50%	Very high	Very high	No	2	2
10	Yes	50%	Very high	Very high	No	4	4

Physical drive utilization, read performance, and write performance depend on the number of drives in the array. Generally, the more drives in the array, the better the performance.

RAID 0 (Non-RAID Arrays)

An array with RAID 0 includes two or more disk drives (maximum twelve) and provides data *striping*, where data is distributed evenly across the disk drives in equal-sized sections.

RAID 0 arrays do not maintain redundant data, so they offer no data protection. However, compared to an equal-sized group of independent disks, a RAID 0 array provides improved I/O performance.

Drive segment size is limited to the size of the smallest disk drive in the array. For instance, an array with two 250 GB disk drives and two 400 GB disk drives can create a RAID 0 drive segment of 250 GB, for a total of 1000 GB for the volume, as shown in the following figure.

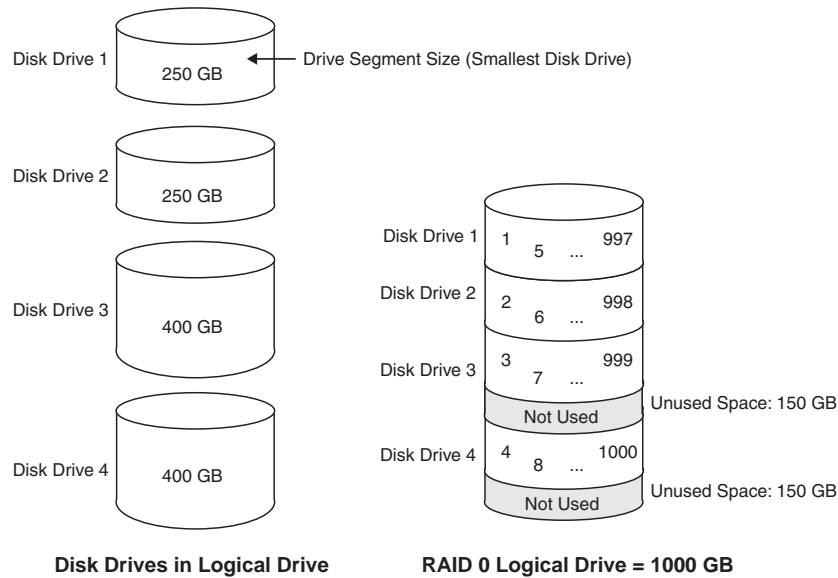

RAID 1 Arrays

A RAID 1 array is built from two disk drives, where one disk drive is a *mirror* of the other (the same data is stored on each disk drive). Compared to independent disk drives, RAID 1 arrays provide improved performance, with twice the read rate and an equal write rate of single disks. However, capacity is only 50 percent of independent disk drives.

If the RAID 1 array is built from different-sized disk drives, the free space, drive segment size is the size of the smaller disk drive, as shown in the following figure.

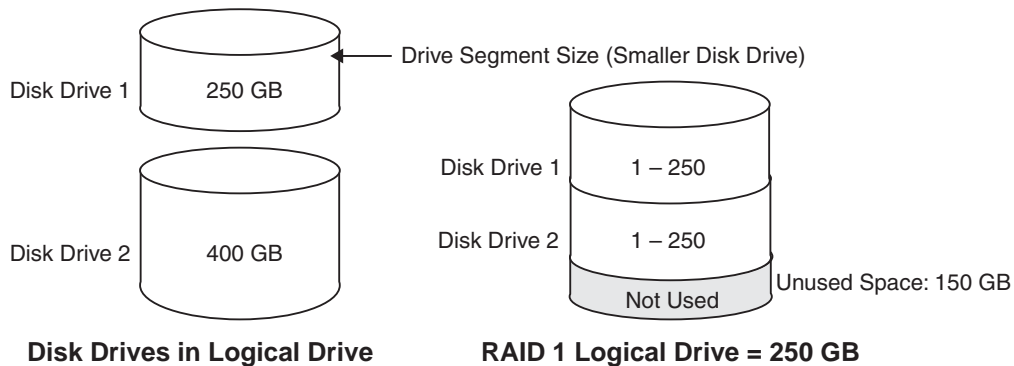

RAID 10 Arrays

A RAID 10 array is built from two or more equal-sized RAID 1 arrays. Adaptec RAID controllers support a maximum number of 48 disk drives in a RAID 10 array.

Data in a RAID 10 array is both striped and mirrored. Mirroring provides data protection, and striping improves performance.

Drive segment size is limited to the size of the smallest disk drive in the array. For instance, an array with two 250 GB disk drives and two 400 GB disk drives can create two mirrored drive segments of 250 GB, for a total of 500 GB for the array, as shown in the following figure.

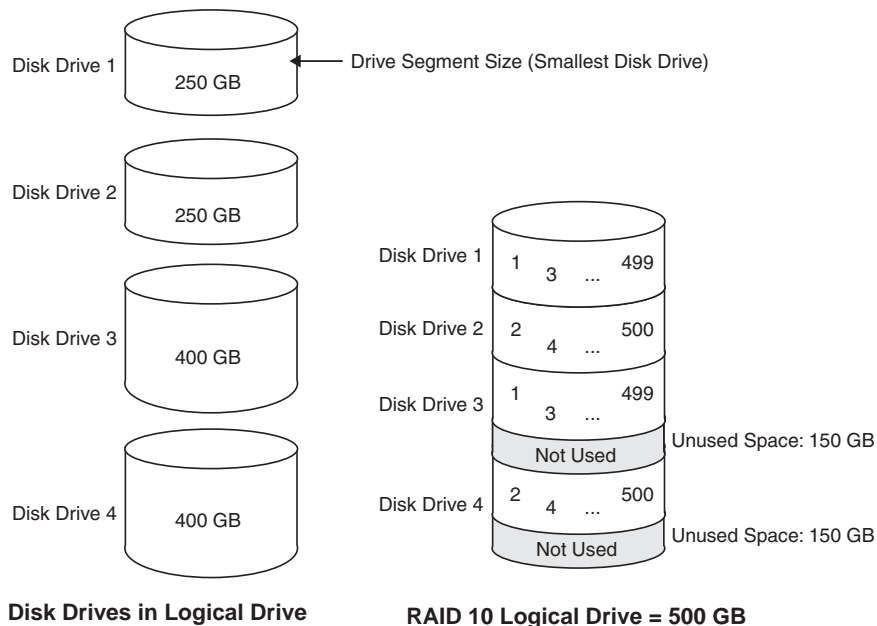

Using the ARC Utility



In this chapter...

Introduction to the ARC Utility	52
Running the ARC Utility.....	52
Creating and Managing Arrays.....	52
Using SATASelect.....	57
Formatting and Verifying Disk Drives	59

The Adaptec RAID Configuration (ARC) utility is an embedded BIOS-based utility that you can use to create, configure, and manage arrays, and format or verify disk drives.

Note: Adaptec recommends that only advanced users familiar with working in a computer BIOS use the ARC utility tools.

Introduction to the ARC Utility

The ARC utility comprises these tools:

- **The Array Configuration Utility (ACU)**—Used to create, configure, and manage arrays, and initialize and rescan disk drives.
- **SATASelect Utility**—Used to change device and HostRAID controller settings.
- **Disk Utilities**—Used to format or verify disk drives (see [page 59](#)).

Running the ARC Utility

All the tools within the ARC utility are menu-based and instructions for completing tasks display on-screen. Menus can be navigated using the arrows, Enter, Esc, and other keys on your keyboard.

To run the Utility:

- 1 Start or restart your computer. When prompted, press **Ctrl+A**.

The ARC utility menu displays presenting these options:

- Array Configuration Utility (ACU)
- SATASelect Utility
- Disk utilities

To select an option from this menu, or from any of the menus within the ARC utility setup, browse with the arrow keys, then press **Enter**. In some cases, selecting an options displays another menu. To return to the previous menu at any time, press **Esc**.

Creating and Managing Arrays

Before creating arrays, make sure the disks for the array are connected and installed in your system. Note that disks with no usable space are shown in gray and cannot be used.

Creating a New Array

To create an array:

- 1 Select **Create Array** from the main ACU menu.

Note: For more information about RAID levels and using disk drives to create arrays, see [Understanding RAID on page 47](#).

- 2 Select the disks for the new array, then press **Insert**. To deselect any disk, highlight the disk, then press **Delete**.
- 3 Press **Enter** when all disks for the new array are selected. The Array Properties menu displays.

Assigning Array Properties

Once the array is created and its properties are assigned, you cannot change the array properties using the ACU. Instead, use Adaptec Storage Manager (See [Chapter 10](#), for details.)

To assign properties to the new array:

- 1 In the Array Properties menu, select an array type, then press **Enter**.
Only the available array types, RAID 0, 1, and 10 are displayed. RAID 0 and 1 requires two to four drives. RAID 10 requires a minimum of four disk drives.
- 2 **Optional:** Type a label of no more than 15 characters for the array, then press **Enter**.
- 3 For RAID 0, select the desired stripe size. Available stripe sizes are 16, 32, and 64 KB (default).

Note: It is recommended that you do not change the default.

- 4 The options under **Create RAID Via** allows you to select between the different creation methods for RAID 0, 1, and 10. The following table gives examples of when each is appropriate.

RAID Level	Create RAID Via	When Appropriate
RAID 0	Quick Init	Creating a RAID 0 on new drives.
RAID 0	Migrate	Allowed only if both selected drives are Simple Volumes. Creating a RAID 0 and you want to preserve data on an existing drive. You will be asked to select the source drive. The contents of the source drive are preserved and any data on the new drive is lost. Note: If there are any medium errors during the first phase of the migration, then the user will be informed about the medium error (LBA number and port number) and the array will be deleted. Members will be reverted to simple volume. If there is any medium error during the second phase of migration, then the user will be informed of the error and migration will be continued.
RAID 1	Build	Creating a RAID 1 and you want to preserve data on an existing drive. You will be asked to select the source drive. The contents of the source drive are preserved and any data on the new drive is lost.
RAID 1, 10	Clear	Creating a RAID 1 or 10 on new drives, or when you want to ensure that the new array contains no existing data.
RAID 1, 10	Quick Init	Fastest way to create a RAID 1 or 10. Appropriate when using a new drive.

Note:

- Before adding a new drive to an array, back up any data contained on the new drive. Otherwise, all data will be lost.
- Only disk drives that were previously configured as simple volumes can be used for RAID 0 or 1 migration when the single/source drive has data on it. See [Configuring Disk Drives on page 56](#) to create a simple volume.
- If you stop the build or clear process on a RAID 1 from ACU, you can restart it by pressing **Ctrl+R**.
- A RAID 1 and 10 created using the Quick Init option may return some data mismatches if you later run a consistency check. This is normal and is not a cause for concern.
- If you stop the migration process on a RAID 0, you can restart it by pressing **Ctrl+R**.

- To modify the Write Cache setting for an array, press **Ctrl+W**.
 - The ACU allows you to use drives of different sizes in a RAID 1. However, during a build operation, only the smaller drive can be selected as the source drive.
 - When migrating from single volume to RAID 0, migrating from a larger drive to a smaller drive is allowed. However, the destination drive must be at least half the capacity of the source drive.
 - It is not recommend that you migrate or build an array on Windows dynamic disks (volumes), as it will result in data loss.
- 5 When you are finished, press **Done**.

Managing Arrays

Select the **Manage Arrays** option to perform these tasks:

- Rebuild Arrays
- View Array Properties
- Delete Arrays
- Enable/Disable Write Cache
- Verify Arrays

The following sections describe these operations in greater detail.

Rebuilding Arrays

Note: Rebuilding applies to Fault Tolerant arrays (RAID 1) only.

Before rebuilding an array, note the following:

- If no spare exists and a hard disk drive fails, you need to create a spare before you can rebuild an array. See [Adding/Deleting Hotspares on page 56](#) before continuing your rebuild.
- If there is any medium error occurring on the disk while rebuilding, the operation is stopped and the array state is marked as degraded. You will be informed about the error (LBA no and port number of the drive are displayed).

By replacing a failed drive of a RAID 1 array with a new drive, you can rebuild to get the array to Optimal status and assume fault tolerance. You can perform a rebuild in the following ways:

- **System Shutdown Rebuild**

You can shut down the system and replace the failed drive with a new one (of equal or greater capacity). When the system is booted, you can assign the new drive as a spare, and this will start the Rebuild task. All the data from the good drive is copied to the new one, and the original RAID 1 array is recreated.

- **Manual Rebuild**

- a From the Main Menu, select **Manage Arrays**. From the List of Arrays, select the array you want to rebuild.
- b Press **Ctrl+R** to rebuild.

- **Force from Offline**

The Hotkey Ctrl+F under manage arrays will make the failed array usable. Below is a list of states applied:

- Failed simple volume will be marked as optimal state
- Failed R1 will be marked to degraded state
- Failed R10 will be marked to degraded state

Viewing Array Properties

To view the properties of an existing array:

- 1 From the ACU menu, select **Manage Arrays**.
- 2 From the List of Arrays dialog box, select the array you want to view, then press **Enter**.

The Array Properties dialog box appears, showing detailed information on the array. The physical disks associated with the array are displayed here.

- 3 Press **Esc** to return to the previous menu.

Deleting Arrays

 **Caution:** Back up the data on an array before you delete it. Otherwise, all data on the array is lost. Deleted arrays cannot be restored.

To delete an existing array:

- 1 From the ACU menu, select **Manage Arrays**.
- 2 Select the array you wish to delete, then press **Delete**.
- 3 In the Array Properties dialog box, select **Delete**, then press **Enter**. The following prompt is displayed:

For Simple volumes with partitions:

 **Warning:** Do you want to delete the partition table? (Yes/No):

For RAID 1 and 10 arrays:

 **Warning:** Deleting the array will render array unusable. Do you want to delete the array? (Yes/No):

For RAID 0 arrays:

 **Warning:** Deleting the array will result in data loss! Do you want to delete the array? (Yes/No):

- 4 If you press **Yes**, select the member when the following prompt is displayed:

To delete the partition table, choose which member:
member #0, member #1, both, none

- 5 Press **Esc** to return to the previous menu.

Enabling/Disabling Write Cache

To Enable/Disable Write Cache for an array:

- 1 From the Main menu, select **Manage Arrays**.
- 2 From the List of Arrays, select the array you want to modify the Write Cache setting for, then press **Ctrl+W**. A confirmation dialog appears to modify setting. Press **Y** to change the current Write Cache setting.

Note: Write Cache is disabled by default when creating all array types. The disk operation may be very slow with Write Cache off.

Adding/Deleting Hotspares

Select the **Add/Delete Hotspares** option to add, delete, or view hot spares.

- 1 From the ACU menu, select **Add/Delete Hotspares**.
- 2 Use the up and down arrow keys to highlight the disk you want to designate as a hot spare, then select **Insert>Enter**.
- 3 Press **Yes** when the following prompt is displayed:

Do you want to create spare? (Yes/No)

The Spare you have selected appears in the Selected Drive menu.

Managing Bootable Arrays and Devices

Select the **Manager Boot Unit** option to add or remove a bootable array or single drive.

- 1 From the ACU menu, select **Manage Boot Unit**.
- 2 Use the up and down arrow keys to highlight the array or single drive you want to designate as a bootable device, then select **Insert>Enter**.

Configuring Disk Drives

Caution:

- If the drive is used in an array, you may not be able to use the array again. Do not configure a drive that is part of a boot array. To determine which drives are associated with a particular array, see [Viewing Array Properties on page 55](#).
- The partition table on the disk will be deleted when deleting a simple volume.
- Arrays can be created using simple volume. However, existing partitions in the simple volume would be erased.

Note: Configuring disk drives makes a simple volume. A simple volume can be managed like normal arrays by using the **Manage Arrays** option on your Main menu.

To configure drives:

- 1 From the menu, select **Configure Drives**.
- 2 Use the up and down arrow keys to highlight the disk you wish to configure, then press **Insert**.
- 3 Repeat [Step 2](#) if you want to add another drive to be configured.

- 4 Press **Enter**.
- 5 Read the warning message and ensure that you have selected the correct disk drives to configure. Type **Y** to continue.

ATAPI Support

The following devices are supported:

- The 1220SA supports detection of SATA ATAPI TAPE Drive and CDROM.
- The 1220SA supports booting from the ELTORITO bootable CD/DVD media.
If a bootable CD/DVD media is detected, that bootable media gets precedence in the booting order.

Using SATASelect

The *SATASelect* utility allows you to change the BIOS and HostRAID controller and device settings without opening the computer cabinet.

For information on the *SATASelect* options, see [SATASelect Options on page 58](#). To access *SATASelect*:

- 1 Restart the computer, then press **Ctrl+A** when prompted to access the ARC utility.
 - 2 If multiple HostRAID controllers are installed, select the HostRAID controller you want to configure, then press **Enter**.
 - 3 From the ARC menu, select **SATASelect Utility**.
 - 4 To select a menu option, browse with the arrow keys to the option, then press **Enter**. In some cases, selecting an option displays another menu. You can return to the previous menu at any time by pressing **Esc**.
 - 5 To restore the original *SATASelect* default values, press **F6** from within the SATA Driver and Controller Configuration screens.
 - 6 To exit *SATASelect*, press **Esc** until a message prompts you to exit (if you changed any settings, you are prompted to save the changes before you exit).
 - 7 At the prompt, select **Yes** to exit, then press any key to restart the computer. Any changes you made in *SATASelect* take effect after the computer restarts.
-

SATASelect Options

The following table lists the available and default settings for each SATASelect option and the description of each option. The default settings are appropriate for most systems and appear in bold type in the table. Adaptec recommends that you do not change the settings.

SATASelect Options	Available Settings	Description
Controller Configuration		
Runtime BIOS	Enabled Disabled Disabled:Scan bus	Controls the state of the BIOS at POST time. When Enabled , the HostRAID controller BIOS allows the controller to act as a bootable device. Disabling the BIOS allows another suitable HostRAID controller to act as the boot device.
BBS Support	Device Controller	When BBS support is set to Device base, the system's BIOS will list each attached bootable device to the HostRAID controller as an individual entry. When BBS support is set to Controller base, the system's BIOS will only list the HostRAID controller in the system boot order. This is useful in a multi-HostRAID controller configuration.
Physical Drives Display during Post	Enabled Disabled	When Enabled , attached physical devices are displayed during system POST. Displaying the devices adds a few seconds to the overall POST time.
SATA Configuration		
Write Cache	Enabled Disabled	Enables or disables write cache on the on legacy and non-configured drives. Write cache enabled provides maximum performance. Default is Yes to enable.
DMA (1420SA only)	Enabled Disabled	Enables or disables the use of Direct Memory Access (DMA) mode for the drive. Enabled provides maximum performance. Default is Yes to enable.
Device Security Lock (1430SA & 1220SA Only)	Enabled Disabled	Enables or disables the device security lock option. When enabling this option, a Security Freeze Lock command is issued to the device.
SMART	Enabled Disabled	Enables or disables the predictive failure feature of the disk drive. When enabled the SMART status of the drive (Healthy or Failed) will be displayed along with the physical drive display during POST. If the drive does not support SMART, the SMART status is not displayed. Default is Yes to enable.
Allow Read Ahead	Enabled Disabled	Enables or disables the read ahead cache algorithm on the drive. Enabled provides maximum performance under most circumstances. Default is Yes.

Formatting and Verifying Disk Drives

You can use the disk utilities to low-level format or verify your disk drives. (New disk drives are low-level formatted at the factory and do not need to be low-level formatted again.)

 **Caution:** Before you format a disk drive, back up all data. Formatting destroys all data on a disk drive.

To use the disk utilities:

- 1 Turn on your computer and press **Ctrl+A** when prompted to access the ARC utility.
- 2 From the ARC utility menu, select **Disk Utilities**.
- 3 Select the desired disk, then press **Enter**.

You are offered the following options:

- **Format Disk**—Simulates a low-level format of the disk drive by writing zeros to the entire disk. SATA drives are low-level formatted at the factory and do not need to be low-level formatted again.

 **Caution:** Formatting destroys all data on the disk. Be sure to back up your data before performing this operation.

- **Verify Disk Media**—Scans the media of a disk drive for defects.
-

C

Using the AFU for DOS

In this chapter...

Introduction	61
Running the AFU from the GUI.....	62
Running the AFU from the Command Line.....	62
AFU Command Line – Step-by-Step	65

This chapter describes how to use the Adaptec Flash Utility (AFU), a text-based DOS utility that you can use to update, save, or verify the HostRAID controller's firmware BIOS.

 **Caution:** Although the AFU contains safeguards to prevent you from accidentally damaging your HostRAID controller's flash contents, it is still important to use the AFU carefully and correctly to avoid rendering your HostRAID controller inoperable. Adaptec recommends that only advanced users familiar with working in DOS use the AFU. For more information, see [Managing Your Storage Space on page 36](#).

Introduction

The AFU is a DOS utility used to update, save, or verify the HostRAID controller's firmware BIOS.

The AFU is easy to use and contains safeguards to prevent you from accidentally damaging the HostRAID controller's flash contents. Still, you must be careful to use the AFU correctly, otherwise, you could render the HostRAID controller inoperable.

The AFU is used to:

- **Update**—Updates all the flash components on a HostRAID controller with the flash image data from a User Flash Image (UFI) file.

The AFU updates the HostRAID controller's flash by reading UFI files and writing them to the controller's flash components.

Note: The UFI includes the HostRAID controller's type, thereby ensuring that the AFU uses the correct file.

- **Save**—Updates and verifies the BIOS image of the controller.
- **Verify**—Reads the contents of a HostRAID controller's flash components and compares it to the contents of the specified UFI file.
- **Version**—Displays version information about a HostRAID controller's flash components.
- **List**—Lists all supported HostRAID controllers detected in your system.

System Requirements

The requirements for AFU are as follows:

- **MS**—DOS version 5.0 or later. It cannot run from a DOS command prompt window under any version of Windows.

Note: You cannot create a bootable floppy using Windows 2000.

- At least 8 MB of extended memory.

Compatibility

The AFU has the following compatibility issues:

- Supports HIMEM.SYS and is compatible with other DOS drivers running under HIMEM.SYS (for example, SMARTDRV.SYS and SETVER.SYS).
 - Does not support DOS extenders installed in memory, such as EMM386.SYS and DOS4GW.
-

Running the AFU from the GUI

The easy way to run the AFU is to use its GUI. If you prefer to run the AFU from the command line, see *Running the AFU from the Command Line* on page 62.

To access the AFU:

- 1 Shut down your operating system and reboot to DOS from a bootable MS-DOS floppy disk or from a DOS partition on a bootable drive. (You can use the drive connected to the HostRAID controller you are updating.)

Note: When updating the HostRAID controller flash, controller activity is not possible. Before you can use the HostRAID controller again, complete the flash operation and restart the computer.

- 2 At the DOS command prompt (typically A:\>) type `AFU`, then press **Enter**.

The AFU's main menu is displayed.

- 3 Select **Select Controllers**, then select the Adaptec HostRAID controllers to be flashed. When selecting a single controller, the system automatically selects it. When selecting multiple controllers, use the spacebar, then press **Enter**.
- 4 Select **Select an Operation** and choose one of the available options, then follow the on-screen instructions.

Running the AFU from the Command Line

At the DOS command prompt (typically A:\>), type `AFU` followed by a command and any switches. The AFU processes the command, prompts you to insert additional floppy disks as needed, exits, and reports success or an error message code. The following available commands are summarized in alphabetical order.

HELP

The `HELP` command displays a summary of AFU functions and command switches.

Examples

The following are examples of command syntax that will work to get help:

```
A:\> AFU HELP
```

```
A:\> AFU /?
```

LIST

The `LIST` command displays the AFU-supported HostRAID controllers installed on your computer. Use this command to see which HostRAID controllers are installed, or to identify the ID numbers assigned to each physical controller.

You do not have to restart the computer after completing this command.

Example

This example shows a typical system response to a LIST command:

```
A:\> AFU LIST

Adaptec Flash Utility V1.0-0 B1406
(c)Adaptec Inc. 1999-2005. All Rights Reserved.
Controllers Detected and Recognized:
Controller #0 (03:01:00) Adaptec ASC-48300
```

SAVE

The SAVE command saves the contents of a HostRAID controller's flash in a UFI file. The name of the UFI file is based on the HostRAID controller type and cannot be changed.

Command Syntax

The command syntax for the SAVE command is as follows:

```
AFU SAVE [/C<Controller ID>] [/D <UFI File Path>]
```

Command Switches

The following switches are available:

- */C <Controller ID>* is one or more HostRAID controller IDs representing the set of controllers on which to perform the specified command. The default is 0, which means that if the computer has multiple HostRAID controllers, the AFU defaults to controller 0 unless you specify otherwise.

You can specify a single HostRAID controller ID, for example:

```
/C 0
```

multiple IDs separated by commas, for example:

```
/C 0,2
```

or ALL to indicate all HostRAID controllers.

Note: If you are using multiple HostRAID controllers, you must specify the controller you want by using the */C* switch; otherwise, the AFU displays an error message and exits. You cannot select ALL HostRAID controllers when specifying SAVE.

- */D <UFI File Path>* specifies the path (drive and directory) where the UFI files are located. If you do not specify the */D* switch, the AFU looks for, or creates, UFI files in the default location.

Note: You cannot specify the name of a UFI file, only its path. UFI filenames are predefined, based on the HostRAID controller type.

Examples

In the following example, the AFU saves flash contents from HostRAID controller 0 to a UFI file in the current default drive and directory:

```
A:\> AFU SAVE /C 0
```

In the following example, the AFU saves flash contents from Controller 1 to a UFI file in C:\UFI_FILES.

```
A:\> AFU SAVE /C 1 /D C:\UFI_FILES
```

UPDATE

The `UPDATE` command updates a HostRAID controller's flash components from the flash image data in a UFI file. You can use the `UPDATE` command to update a single HostRAID controller's flash components or to update multiple HostRAID controllers on your computer.

You must restart the computer following an `UPDATE` command.

Command Syntax

The command syntax for the `UPDATE` command is as follows:

```
AFU UPDATE [/C<Controller ID>] [/D <UFI File Path>]
```

Command Switches

For details on the `/C` and `/D` switches, see [SAVE on page 63](#).

Examples

The following example shows a typical system response after an update has been performed:

```
A:\> AFU UPDATE /C 0

Adaptec Flash Utility V1.0-0 B1406
(c)Adaptec Inc. 1999-2005. All Rights Reserved.
Updating Controller 0 (Adaptec AAR-1430)
Reading flash image file (Build 1406)
AFU is about to update firmware on controller(s) Adaptec AAR-1430
***PLEASE DO NOT REBOOT THE SYSTEM DURING THE UPDATE***
This might take a few minutes.
Writing Adaptec AAR-1430 (4MB) Flash Image to controller 0...OK.
Verifying...OK
Please restart the computer to allow firmware changes to take effect.
```

VERIFY

The `VERIFY` command compares the contents of each of the flash components on a HostRAID controller to the corresponding image in a UFI file and indicates whether they match. Use this command to determine whether a HostRAID controller's flash components are up-to-date when compared to a specific UFI file.

Command Syntax

The command syntax for the `VERIFY` command is as follows:

```
AFU VERIFY [/C<Controller ID>] [/D <UFI File Path>]
```

Command Switches

For details on the `/C` and `/D` switches, see [SAVE on page 63](#).

Example

The following example shows a typical system response after a `VERIFY` command has been performed:

```
A:\> AFU VERIFY /C 0
Adaptec Flash Utility V1.0-0 B1406
(c)Adaptec Inc. 1999-2005. All Rights Reserved.
Reading flash image file (Build 1406)
Controller #0: Adaptec AAR-1430
File: Checksum: 642C [VALID] (Build 1406)
File: Checksum: 642C [VALID] (Build 1406)
Verified Successfully
```

VERSION

The `VERSION` command displays version information about the flash components on a HostRAID controller.

Command Syntax

The command syntax for the `VERSION` command is as follows:

```
AFU VERSION [/C<Controller ID>]
```

Command Switches

For details on the `/C` switch, see [SAVE on page 63](#).

Example

The following example displays version information about all supported HostRAID controllers:

```
A:\> AFU VERSION /C 0
Adaptec Flash Utility V1.0-0 B1406
(c)Adaptec Inc. 1999-2005. All Rights Reserved.
Version Information for Controller #0 (Adaptec AAR-1430)
ROM: Build 1406 [VALID]
```

AFU Command Line – Step-by-Step

This section provides step-by-step instructions for updating the flash.

To update the flash using the AFU command line:

- 1 Shut down the computer.
- 2 Insert the bootable disk that contains the AFU utility.
- 3 Turn on the computer.
- 4 Enter the system setup utility and verify that your computer is set up to boot from the bootable disk.

- 5 If you have multiple HostRAID controllers only—At the DOS prompt, type `afu list`, then press **Enter**.

This command displays the Adaptec SATA HostRAID controllers in your system. Note the HostRAID controller number for the controller you want to update; you may need it in Step 6 to perform the update.

- 6 You can update the flash using any of the following alternatives:
 - a **Updating the Flash on a Single HostRAID Controller**—To flash the firmware on a single HostRAID controller, type:

```
afu update /C <controller_number>
```

Where *controller_number* is the number of the controller whose firmware you are updating. For example, to upgrade Controller 0, type:

```
afu update /C 0
```

- b **Updating the Flash on Multiple Controllers**—To flash the firmware on multiple HostRAID controllers, type:

```
afu update /C <controller_number_a>,<controller_number_b>
```

Where *<controller_number_a>* and *<controller_number_b>* are the number of one of the Adaptec HostRAID controllers whose firmware you are updating.

To upgrade HostRAID controllers 0, 2, and 3 for example, type:

```
afu update /C 0, 2, 3
```

- c **Updating the Flash on All HostRAID Controllers Simultaneously**—To flash the firmware on all HostRAID controllers, type:

```
afu update /C all
```

Note: The UFI file identifies the appropriate HostRAID controllers, so you do not have to worry about flashing the wrong controller.

- 7 The AFU prompts you to put in the first firmware disk.
When it detects that the disk is in the drive, the AFU reads the part of the firmware image contained on the first disk.
- 8 When prompted, remove the first firmware disk and insert the second firmware disk.
- 9 If necessary, repeat [Step 8](#) until the process is complete.

Safety Information



To ensure your personal safety and the safety of your equipment:

- Keep your work area and the computer clean and clear of debris.
- Before opening the system cabinet, unplug the power cord.

Electrostatic Discharge (ESD)

 **Caution:** ESD can damage electronic components when they are improperly handled, and can result in total or intermittent failures. Always follow ESD-prevention procedures when removing and replacing components.

To prevent ESD damage:

- Use an ESD wrist or ankle strap and ensure that it makes skin contact. Connect the equipment end of the strap to an unpainted metal surface on the chassis.
- If a wrist strap is not available, ground yourself by touching the metal chassis before handling the controller or any other part of the computer.
- Avoid touching the controller against your clothing. The wrist strap protects components from ESD on the body only.
- Handle the controller by its bracket or edges only. Avoid touching the printed circuit board or the connectors.
- Put the controller down only on an antistatic surface such as the bag supplied in your kit.
- If you are returning the controller to Adaptec, put it back in its antistatic bag immediately.

Technical Specifications



In this chapter...

- Environmental Specifications..... 69
- DC Power Requirements..... 69
- Current Requirements..... 69

Environmental Specifications

Ambient temperature without battery backup module	0 °C to 50 °C
Relative humidity	10% to 90%, noncondensing
Altitude	up to 3,000 meters

Note: Forced airflow is recommended, but not required.

DC Power Requirements

Ripple and noise	50 mV peak-to-peak (max)
DC Voltage	3.3 V \pm 10%

Current Requirements

Adaptec Model	Maximum Current (A)
AAR-1430SA	1.5A
AAR-1420SA	1.5A
AAR-1220SA	1.5A

Glossary

A

activity

See *task*.

ACU

Array Configuration Utility. An application used to create, configure, and manage arrays from the controller's BIOS or MS-DOS.

array

A logical disk created from available space and made up of one or more segments on one or more physical disks. Arrays are typically used to provide data redundancy or enhanced I/O performance. See *volume*, *spanned volume*, *RAID 0*, *RAID 1*, *RAID 10*. Also known as a container.

array initialization

See *configure*.

ATA

AT Bus Attachment. Standard parallel interface to IDE hard disks typically used in desktop computers and some entry-level servers. Serial ATA (SATA), is a successor to parallel ATA, which is sometimes referred to as PATA.

available space/segment

Unused space on a configured disk from which logical devices (arrays) are created. When an array is deleted, the space that it used is returned to the available space pool.

B

background consistency check

Option that forces the controller to constantly check all portions of disks used by all arrays to see if the disks can return data from the blocks. See *consistency check command*.

bad segment

Segment that is in an unknown state.

bootable array

Array configured as the boot device.

build

Background initialization of a redundant array. The array is accessible throughout. RAID 1 copies the contents of the primary drive to a secondary drive. See [clear](#).

bus

See [channel](#).

C**cache**

Fast-access memory on the controller that serves as intermediate storage for data that is read from, or written to, drives.

capacity

Total usable space available in megabytes or gigabytes.

channel

Any path, or bus, used for the transfer of data and the control of information between storage devices and a RAID controller. For SATA channels, each channel has a single drive capacity.

check point

A feature that enables you to exit the ACU when an operation is in progress and be able to continue without interruption. The driver then resumes the operation from where the BIOS left off and the BIOS resumes the operation where the driver left off.

chunk

See [stripe](#).

clear

Foreground initialization of a fault-tolerant array. A clear operation zeros all blocks of the array. The array is not accessible until the clear task is complete.

concatenation

Joining of physical or logical drives in sequential order.

configure

Process of preparing a disk for use by the controller. When a disk is configured, the controller records the RAID signature on the disk.

configured array

An array that is ready for data reads and writes. Arrays can be configured by build or clear.

consistency check command

Command that reads all the blocks of a RAID 1 to determine if the blocks are consistent. Any inconsistent blocks are fixed.

D**dead partition**

See [failed](#).

degraded

A redundant (for example, a RAID 1) array in which one or more members have failed. The data is intact but redundancy has been compromised. Any further failure would cause the array to fail and result in data loss.

disk

Physical disk drive. Randomly accessible, rewriteable data storage device. Also called hard disk.

disk ID

Unique disk identifier that consists of the channel number, SATA ID. For example, (channel:ID:LUN) 1:04:0. See [channel](#).

drive LED

Disk indicator LED that illuminates during read or write operations.

E**event**

Notification or alert from the system, indicating that a change has occurred.

event log

File used to maintain information about prior controller activities or errors.

event notification

Process for transmitting events.

F**failed**

State of a nonredundant array that has suffered a single drive failure, or a redundant array that has suffered multiple drive failures. A failed array is inaccessible and data is lost.

fault-tolerant array

Refers to an array that can continue to function after a disk drive failure without loss of data. Fault tolerant, or redundant arrays, include RAID 1 arrays. See [redundant](#).

foreign disk

Disk that has previously been configured on another Adaptec RAID controller. The RAID signature on the disk allows the RAID controller to identify whether or not the disk was configured on the controller it is currently connected to.

H**hard disk drive**

Basic unit of nonvolatile, nonremovable, magnetic storage media. See [disk](#).

hot spare

A spare hard disk that automatically replaces a failed hard disk on any array associated with any HBA.

hot swap

To remove a component from a system, and install a new component while the power is on and the system is running.

I**impacted**

An impacted array is one which has been created but for some reason the initial build operation did not complete. All member drives are present and operational, and all data written to the array is protected. To optimize the array, run a Verify with Fix Task.

initialize

See [configure](#).

L

legacy disk

Disk that contained a valid partition table when connected to the controller. The controller manages the disk as a legacy disk array where there is a one-to-one logical-to-physical mapping of array to disk.

logical device

Volume comprised of space from one or more physical drives and presented to the operating system as if it were a single storage unit.

low-level format

Process performed by the drive firmware that completely cleans any data off the hard disk.

M

mirrored array/mirroring

See [RAID 1](#), [RAID 10](#).

monitoring

Process of receiving, displaying, and logging system events.

N

Native Command Queuing

Allows disk drives to arrange commands into the most efficient order for optimum performance.

O

offline array

Array that can no longer be accessed.

optimal

The state of an array when it is fully operational. For redundant arrays, the entire array is protected.

P

partition

A section of a disk storage device created by the operating system disk management program, in which data and/or software programs are stored. Computers have a primary operating system partition that contains the special files needed to boot the computer. Each operating system partition is assigned a unique drive letter, such as C or D. A single disk device can have multiple partitions.

phantom object

Object that represents a component that cannot be configured by the controller management software; for example, a missing drive.

Q

quick init

An array configured using the Quick Init option is available immediately, with no on-going background controller activity. All data written to an array that has been quick configured is protected.

R

RAID

Redundant Array of Independent Disks (alternative definition Redundant Array of Inexpensive Disks).

RAID 0

A single-level array consisting of two or more equal-sized segments residing on different disks. RAID 0 distributes data evenly across its respective drives in equal-sized sections called stripes. RAID 0 arrays are not redundant.

RAID 1

Single-level array consisting of two equal segments residing on two different drives. Provides redundancy by storing identical copies on two drives. See [mirrored array/mirroring](#).

RAID 10

Spanned array consisting of two or more equal-sized RAID 1 arrays. Provides redundancy by striping and mirroring. Mirroring provides data protection, and striping improves performance. See [mirrored array/mirroring](#), [RAID 0](#).

RAID signature

The area on each disk reserved for use by the RAID controller.

RAID volume

Concatenates two or more arrays of the same type.

rebuild

Background regeneration of redundant data on a RAID 1.

redundant

The ability of an array to maintain operability when one or more hardware failures occur. RAID 1 is redundant. In the event of a drive failure, redundant arrays can be restored to normal operation by replacing the failed drive and rebuilding the array.

rescan

Process of updating the current screen to show all currently available resources.

S

Serial ATA (SATA)

A successor to ATA that uses a serial, instead of parallel, interface.

simple volume

A volume made up of disk space from a single disk. It can consist of a single region on a disk, or concatenated multiple regions of the same disk.

single-level array

Array created from one or more segments. See [volume](#), [spanned volume](#), [RAID 0](#), [RAID 1](#), [RAID 10](#).

snapshot

Instantaneous read-only copy of an array at a precise point in time.

spanned volume

A simple volume that spans two or more drives.

stripe

Contiguous set of data distributed across all the disks in an array. A striped array distributes data evenly across all members in equal-sized sections called stripes.

stripe size

The amount of data in each section of a striped array.

striped array

See [RAID 0](#), [RAID 10](#).

T**task**

An operation that occurs only on the RAID controller, asynchronous to all other operations; for example, initializing a disk or verifying an array. Some tasks can take an extended period of time, particularly if the RAID controller is also performing intensive data I/O while the task is running.

V**verify**

Low-level check that a drive, logical device, or hot spare is good. In a RAID 1, verify is a low-level check that contents of both members' segments are consistent and, optionally, corrects errors while assuming that the master drive is correct. In a simple volume, verify performs a low-level check that the whole drive can be read.

volume

See [simple volume](#), [spanned volume](#).

A

ACU

creating arrays [52](#)

Adaptec customer support [3](#)

Adaptec Flash Utility. *See* AFU

Adaptec RAID Configuration Utility. *See* HRCNF

Adaptec Storage Manager

installing [37](#)

AFU [38](#)

Array Configuration Utility. *See* ACU

arrays

creating (ACU) [52](#)

non-RAID [49](#)

RAID 1 [50](#)

RAID 10 [50](#)

C

customer support [3](#)

D

data striping [48](#)

disk drives

connecting to SATA controllers [24](#)

failure recovery

multiple arrays [46](#)

multiple disk drives [46](#)

with hot spare [45](#)

without hot spare [46](#)

formatting [59](#)

recovering from failure [45](#)

verifying [59](#)

drivers

installing on Linux [35](#)

installing on NetWare [35](#)

installing on Windows [34](#)

E

electrostatic discharge [67](#)

F

failed disk drives

multiple arrays [46](#)

multiple disk drives [46](#)

without hot spare [46](#)

formatting disk drives [59](#)

H

hard disk, hard disk drive, hard drive. *See* disk drives

I

installation

disk drives (SATA) [24](#)

L

Linux

driver installation [35](#)

N

NetWare

driver installation [35](#)

non-RAID arrays [49](#)

P

performance tuning

selecting a RAID level [49](#)

stripe-unit size 48

R

RAID

- definition 48
- performance tuning 49
- RAID 0 49
- RAID 1 50
- RAID 10 50

recovering from disk drive failure

Red Hat

- driver installation 35

Redundant Array of Independent Disks. *See* RAID

replacing failed disk drives

S

SATA controllers

- connecting disk drives 24

SATASelect

- using settings 57

SCSI

Serial ATA. *See* SATA

Small Computer System Interface. *See* SCSI

storage management

- ACU 52
- AFU 38
- SATASelect 57

storage space 11

stripe, definition 48

stripe-unit size

- definition 48
- performance tuning 48

support, customer 3

SuSE

- driver installation 35

T

technical support 3

Technical Support Identification (TSID) number 3

terminology 11

- Adaptec Storage Manager 11

throughput 48

tools

- ACU 52
- AFU 38
- ARC 52
- disk utilities 59
- SATASelect 57

TSID Number

- See* Technical Support Identification Number

U

utilities

- AFU 38
- ARC 52
- Disk Drive 59
- SATASelect 57

V

verifying disk drives 59

W

Windows

- driver installation 34



Adaptec, Inc.
691 South Milpitas Boulevard
Milpitas, CA 95035 USA

©2006 Adaptec, Inc.
All rights reserved. Adaptec and the Adaptec logo are
trademarks of Adaptec, Inc. which may be
registered in some jurisdictions.

Part Number: CDP-00181-02-A, Rev. A
JB 09/06